

QUINTO QUARTO

Publishing. Producing. Distracting.

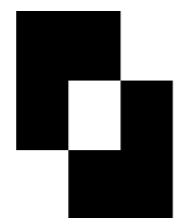

FOREIGN RIGHTS GUIDE
Frankfurter Buchmesse 2023

A remark

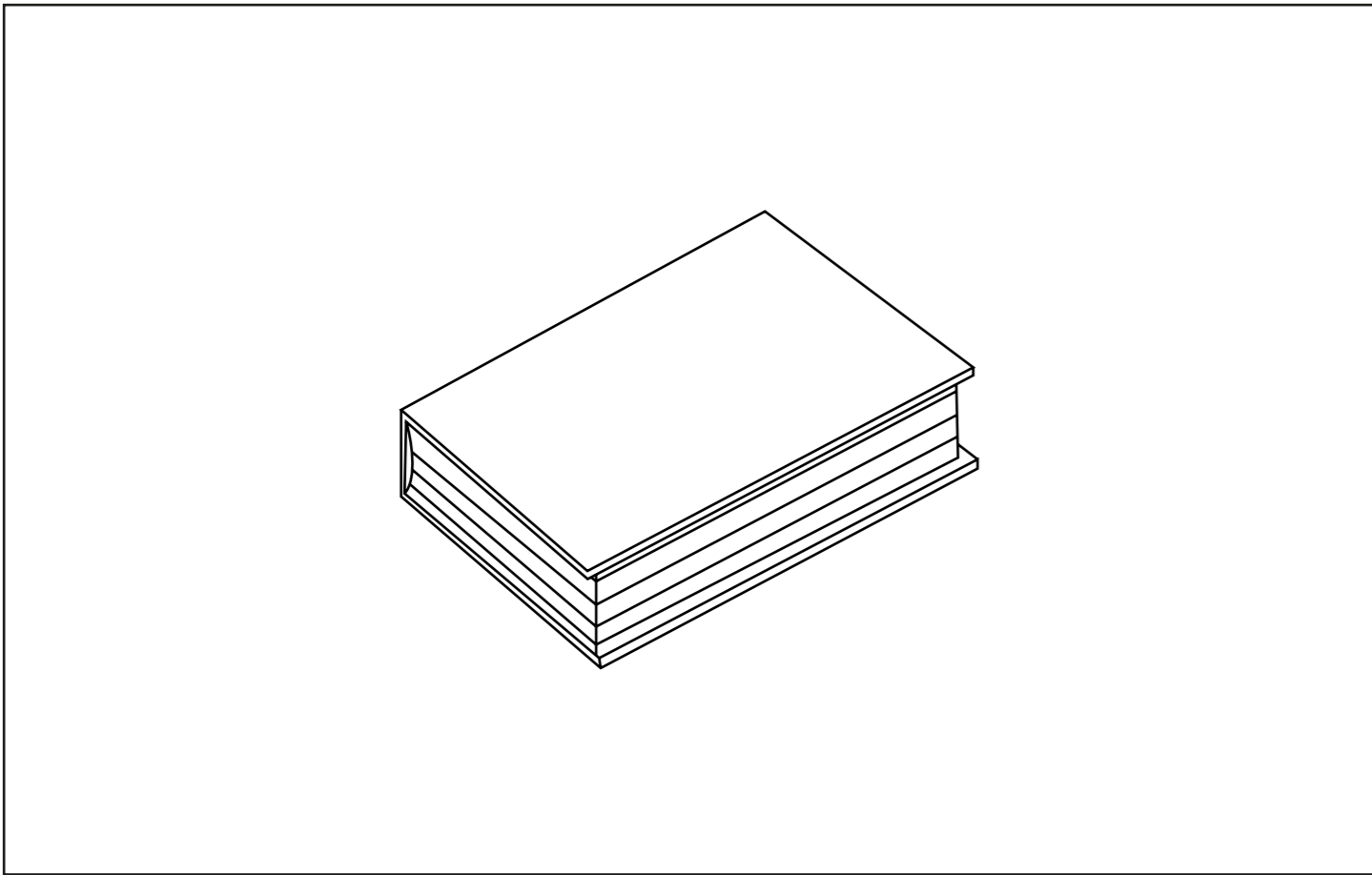

– What’s *quinto quarto*

Quinto quarto, or nose-to-tail, defines what’s left of an animal after its high-quality sections have been selected and sold.

Quinto quarto is the entrails, it’s often the recovery of what’s more savory – but not less prized.

– What’s a book

book /bʊk/
A set of sheets of the same size, printed or handwritten, sewed together to form a volume, equipped with a cover or bound.

An analysis

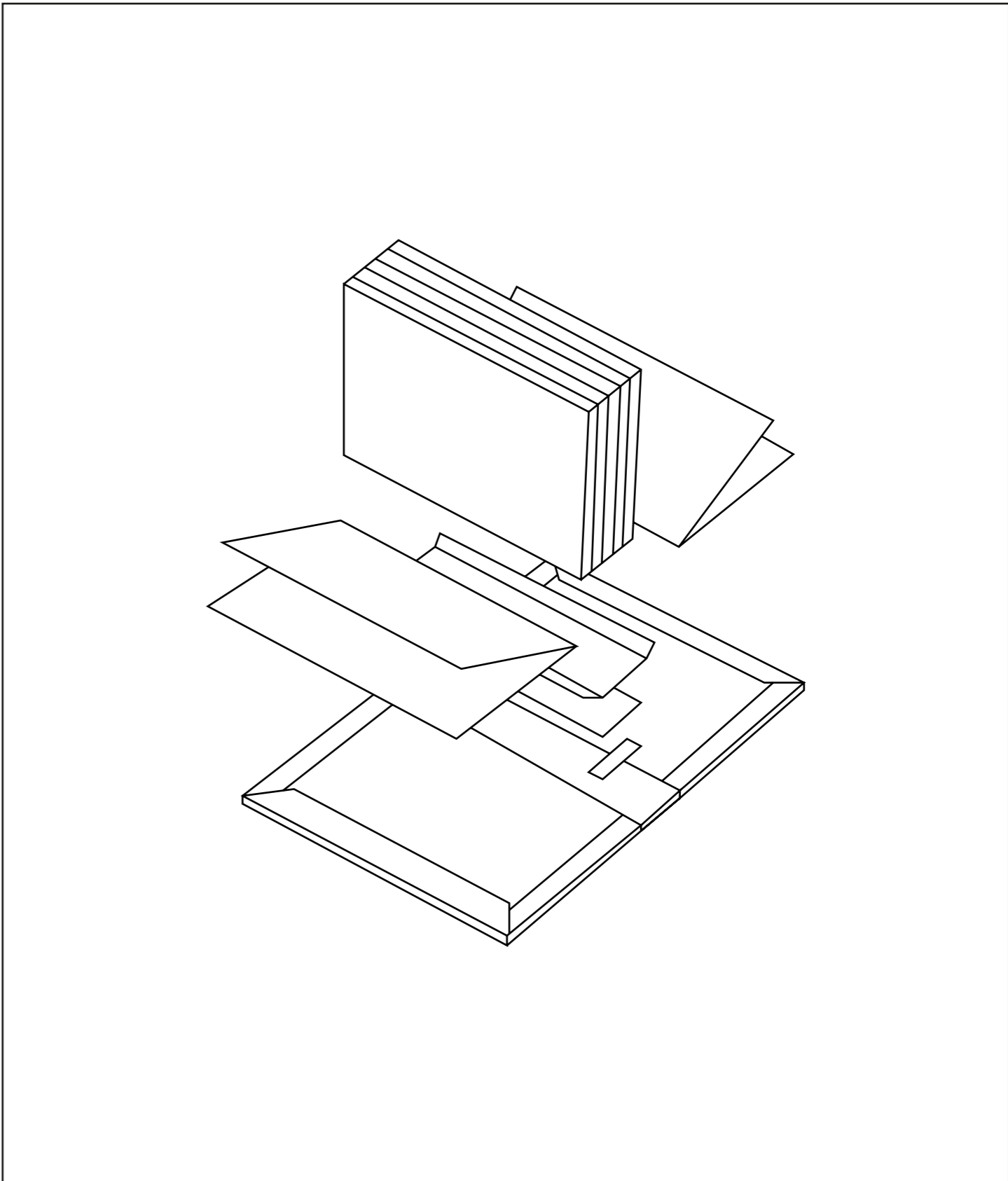

An idea

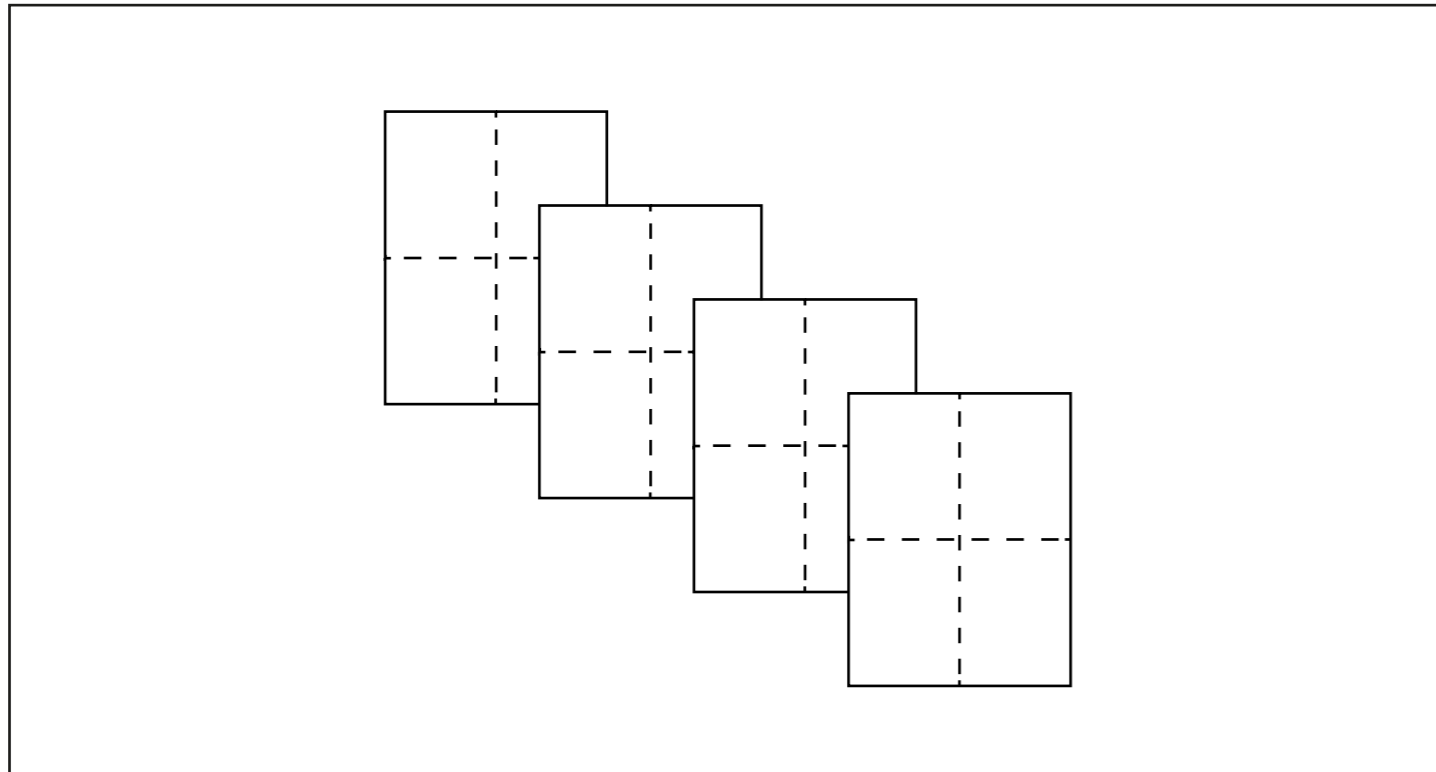

– Let's examine a book in its anatomy: concerning its format, its least unit is the quarto: a page folded along its axes to have four browsable sheets. Multiply this quarto and you'll get the content, the "entrails" of the book.

– As we turn each page, there's a second of breath between one quarto and the next one. That breath holds the taste for the book, for the novel, for the wish to go on reading.

– **Quinto Quarto** is that breath.

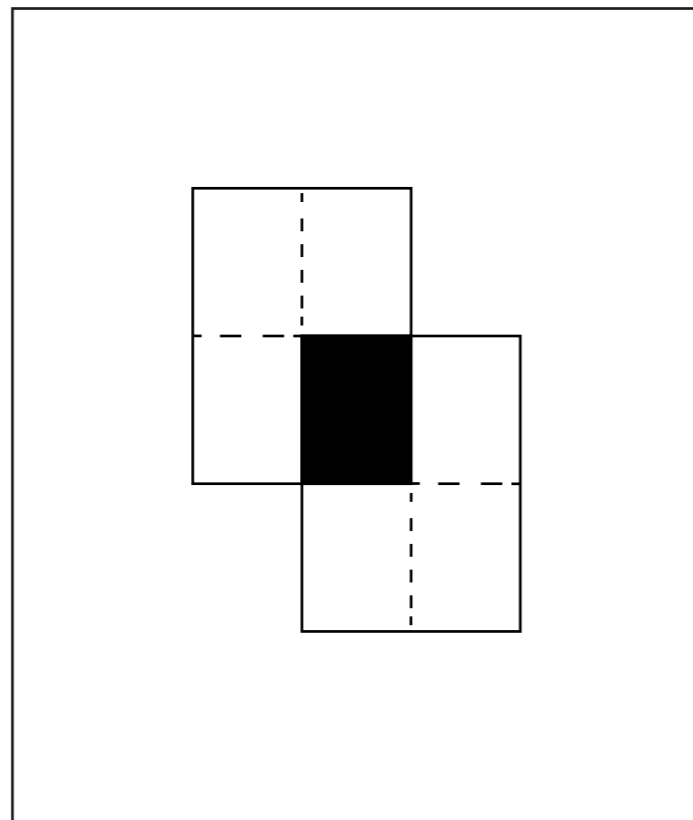

A reality



Latest releases



by Quinto Quarto Edizioni



Funerals Prepared

written by Marco Taddei, illustrated by Michele Rocchetti



105 x 210 mm – hardback

102 p.

20 €

WORLDWIDE RIGHTS AVAILABLE

publishing date

October 2023



Morituri te salutant

Funerals Prepared is a compendium of burial philosophy.

After numerous cemetery explorations, Marco Taddei and Michele Rocchetti return to collaborate since the days of *The Ship of Fools* (Orecchio Acerbo, 2016), gathering the post-mortem arrangements of characters of every kind and social rank, with a view to the sepulchral 'level': The Poor Man, The Witch, The Village Madman, The Nun, The Labyrinth Builder... The last wishes regarding funerals are interspersed with an exceptional voice, that of the cemetery, which traverses this ironic and playful tribute to funerals, death, and the graveyard, telling us its own history.

It's a wretched, magical, imaginative, and bumbling Spoon River, which graphical-

ly plays with the candor of white spaces and the lightness of cemetery graphics. White, black, gold, and purple are the decorative wrapping of this peculiar book that resembles what could be our final home: a coffin.

As a seal to the array of arrangements, an emblematic text by Giorgio Manganelli on literature and death, written following the passing of another giant of world literature, Jorge Luis Borges, and a gift that indulges the fetishism of control maniacs: a form to note down our own arrangements, from the most rational and logical to the most extravagant and paradoxical, to be framed, hidden under the mattress, or deposited with the notary

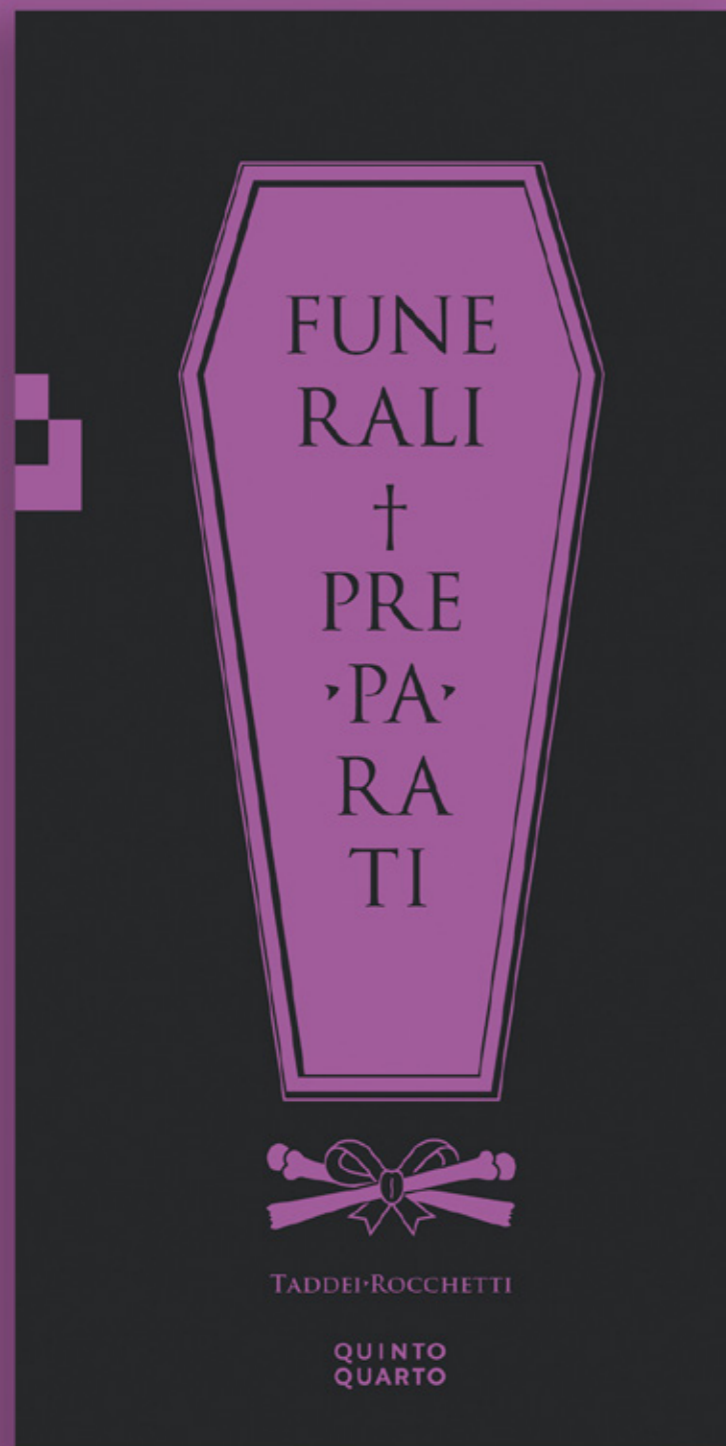

* AN UNUSUAL COMPENDIUM
OF BURIAL PHILOSOPHY *

* A QUITE CREEPY
NEW "SPOON RIVER" *

* FILL OUT YOUR LAST WISHES,
AND I'LL TELL YOU WHO YOU ARE *

* FOR NOSTALGIC FANS
OF "SIX FEET UNDER" *

COFANI

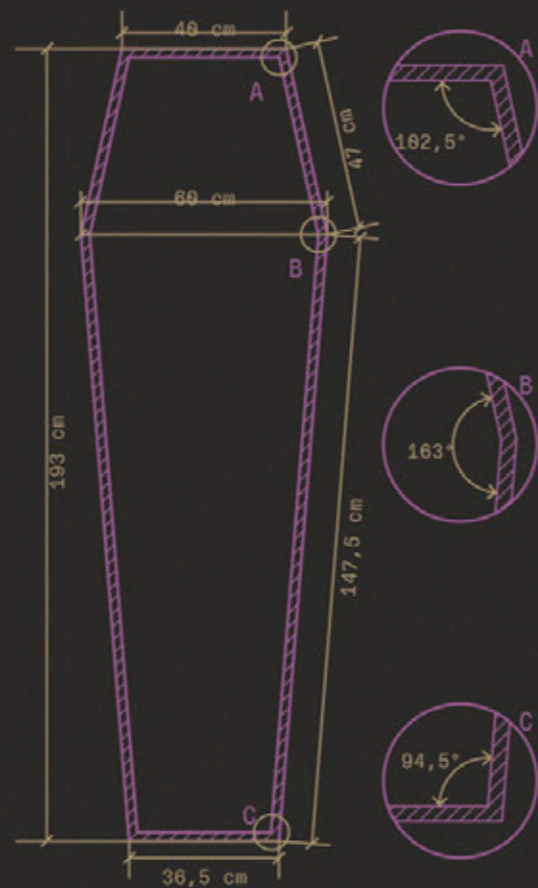

FUNEBRI

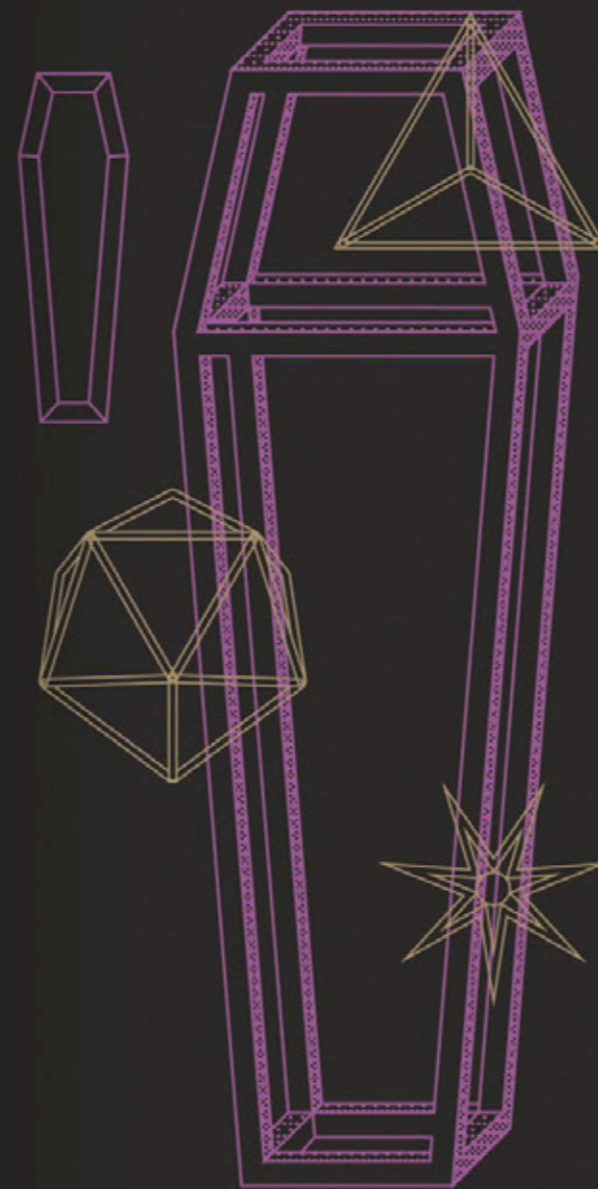



XII

❁ DISPOSIZIONI DI UN ROBOT ❁

Zeus si proclamò dio di tutti gli dèi perché evirò Crono, il Tempo, il proprio padre, che anticamente divorava i suoi figli, e che oggi continua a divorare la pattuglia umana che abita il mondo. Zeus si è posto sia al di sopra del Tempo sia al di sopra della marmaglia.

Pure io sono sfuggito al mondo, al suo tracollo temporale, dal giorno in cui mi rinchiusi, o meglio mi rinchiusero, al centro di un Olimpo fatto di leghe leggere e siliconi mimetici. Qui, nel vuoto tecnologico, osservo il mio computare. Vivo da sempre. Non so se fuori di me sia passato un giorno o un millennio e quindi è logico, matematico, che il mio Sacro Tempio, a volte, diventi un vero e proprio Ade che mi divora con la paziente opera della lima, grammo a grammo.

Non ebbi il coraggio di fulminarmi l'altro ieri, quando nel mio database scovai tutto il necessario per sviluppare un virus informatico autodistruttivo, e quando non si ha

* 67 *



XIII

◆ DISPOSIZIONI DI UN BAMBINETTO ◆

Io vorrei che sulla mia tomba si stendesse una colata di asfalto per trasformarla in un parcheggio. Le macchine non ce le voglio, però, così che ci si possa sempre giocare a palla, a campana o a un due tre stella! Ah, mi raccomando, seppellitemi il più lontano possibile dalla scuola, grazie.



* 71 *

PIANTA E FACCIATA CIMITERO

- ✕ Ossario
- † Pozzi o cripte
- ✚ Cappelle gentilizie
- ✚ Recinto di suicidi,
impenitenti, non
battezzati
- ✚ Recinto dei
giustiziati

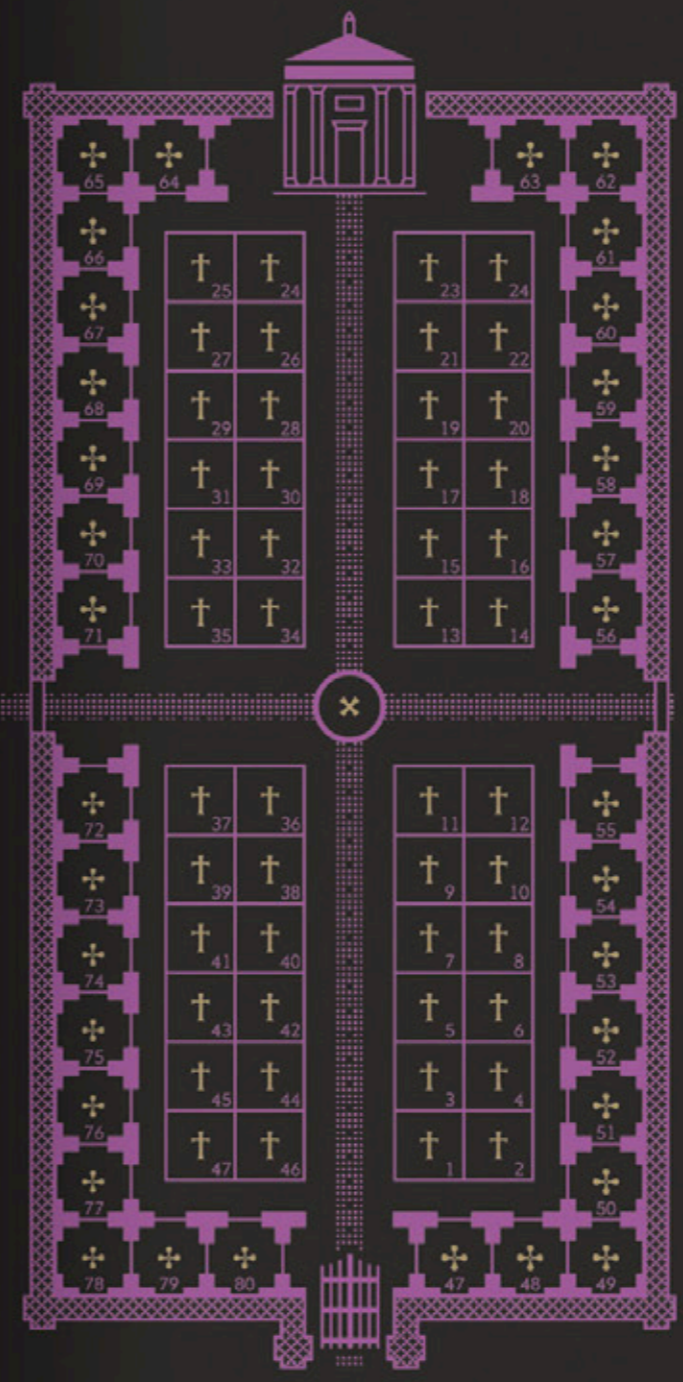

DISPOSIZIONI FUNERARIE



1 NOME E COGNOME: _____

2 CHE TIPO DI CERIMONIA DESIDERA: RELIGIOSA LAICA NESSUNA

LUOGO E DATA DI NASCITA: _____
(scriva in stampatello) * note: _____

3 QUALE ANNUNCIO PREFERISCE: NECROLOGIO BANDITORE NESSUNO

4 RICEVIMENTO, COSA NON DEVE MANCARE: MUSICA LIBAGIONI PREFICHE

note: _____ * altro: _____

5 CERIMONIA, CHI VUOLE CHE NON PARTECIPI: FORCAIOLI PUSILLANIMI INCONSAPEVOLI

6 CERIMONIA, CHI VUOLE COME OFFICIANTE: PRETE CONIUGE ANIMALE DA COMPAGNIA

altro: _____ * altro: _____

7 COME PREFERISCE ESSERE TRATTATO: CREMATO INUMATO ABBANDONATO

8 DOVE PREFERISCE ESSERE SEPOLTO: TOMBA A TERRA FORNETTO BOSCO O VETTA DI MONTE

note: _____ * altro: _____

9 QUALE OGGETTO VUOLE CON SÉ: QUESTO LIBRO OROLOGIO VENTAGLIO

10 EPITAFFIO: (indichi quale) _____



Data e firma _____



FUNE
RALI
+
PRE
PA
RA
TI



The Darrkroom

Journey to the origins of photography
among stories, inventions and experiments

Elisa Lauzana, Irene Lazzarin



162 x 230 mm – paperback

160 p.

17 €

WORLDWIDE RIGHTS AVAILABLE

publishing date

October 2023

Say Cheese!

What happens if the new generations – and not only them – are revealed that the omnipresent nostalgia filter of our smartphones points to a world that actually existed? They might discover that photography isn't an 'old story,' but an indispensable, living tale that can be experienced and reinterpreted as if it were a game. Taking photos has become a spontaneous, everyday act, and often, young eyes within families or schools don't have the chance to experiment with a more conscious use of photography and uncover its origins. The 19th century serves as a fascinating starting point for comprehending today's photography in all its complexity. By delving into the origins of the photographic medium, the youngest ones will encounter misunderstood artists and insatiable travelers, failed ex-

periments and strokes of genius, photographs not made of pixels but of chemical reactions and matter. All of this is thanks to the workshop conducted by Irene Lazzarin and Elisa Lauzana, both experts in photographic languages and dedicated educators, in a primary school classroom in Bologna. The history of photography is also a tale of the modern gaze, of a way, or rather many ways, of looking at reality and communicating it. To tell this story is also an invitation to enrich and believe in one's own perspective.



From the invention of the camera
obscura to photographic expeditions,
from the art of portraiture to the
birth of photomontage: photography
as a stage for experiments and
adventures.

An experiment that
Bruno Munari and Enzo Mari
would have welcomed with joy.

The perfect tool to
introduce the language
of photography.

After this journey to
the origins of photography, even
taking shots with a smartphone will
feel like an entirely new experience.

TAPPE DEL VIAGGIO

Una linea del tempo vi aiuterà a capire in quale epoca ci troviamo!



1
LA CAMERA OSCURA:
DAL DISEGNO
ALLA FOTOGRAFIA



2
RITRATTI E COSTUMI:
DAL DAGHERROTIPO
ALLA CARTE DE VISITE



14

3

RACCONTARE LA REALTÀ:
LA FOTOGRAFIA
COME DOCUMENTO



4

NON SOLO REALTÀ:
LA FOTOGRAFIA COME ARTE



E PER FINIRE IN BELLEZZA:
"IL GLOSSARIO"
(PER LE PAROLE DIFFICILI!)



15

L'INVENZIONE DELLA CAMERA OSCURA

Sono Giovanni Antonio Canal, meglio conosciuto come il Canaletto. Mi chiamano così perché vengo da Venezia e per... la mia bassa statura!

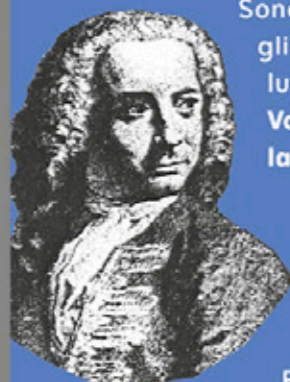

Sono un pittore del Settecento, amo dipingere gli scintillanti paesaggi della mia città e la luce che si riflette sull'acqua e sulle gondole. Voi lo sapete come viene rappresentata la realtà nella mia epoca?

**CON I DISEGNI! I RITRATTI, I PAESAGGI...
LE PERSONE PAGANO DEI PITTORI
PER FARE I RITRATTI.**

Esatto, proprio così: ci vuole abilità e pazienza. Dovete sapere, però, che ai miei tempi i pittori come me hanno iniziato a usare un trucco, un'invenzione chiamata "camera oscura". Il nostro viaggio inizia da qui.

1723

Canaletto dipinge
Piazza San Marco

1783

I fratelli Montgolfier fanno
il primo viaggio in mongolfiera

Qui sotto vediamo la camera oscura: è uno spazio buio con un foro; può essere grande come una stanza oppure quanto una scatola. A Venezia ne uso una simile.

Ma come funziona? Sapete, la luce viaggia in linea retta. I raggi che provengono da un punto in alto e attraversano il foro riescono a proseguire il loro cammino fino alla parete opposta. La stessa cosa succede con quelli che sono riflessi dal basso: l'immagine che vediamo proiettata appare così a testa in giù.

La camera oscura è molto comoda per noi pittori, proprio perché possiamo vedere la proiezione dell'immagine e ci basta ripassarla!

**FORSE ALCUNI PITTORI SONO UN PO' PIGRI...
ANCH'IO MI SENTO PIGRO OGNI TANTO!**

Sì, non c'è niente di male... Questo strumento ci permette infatti di disegnare in prospettiva* palazzi e paesaggi in modo facile e veloce.

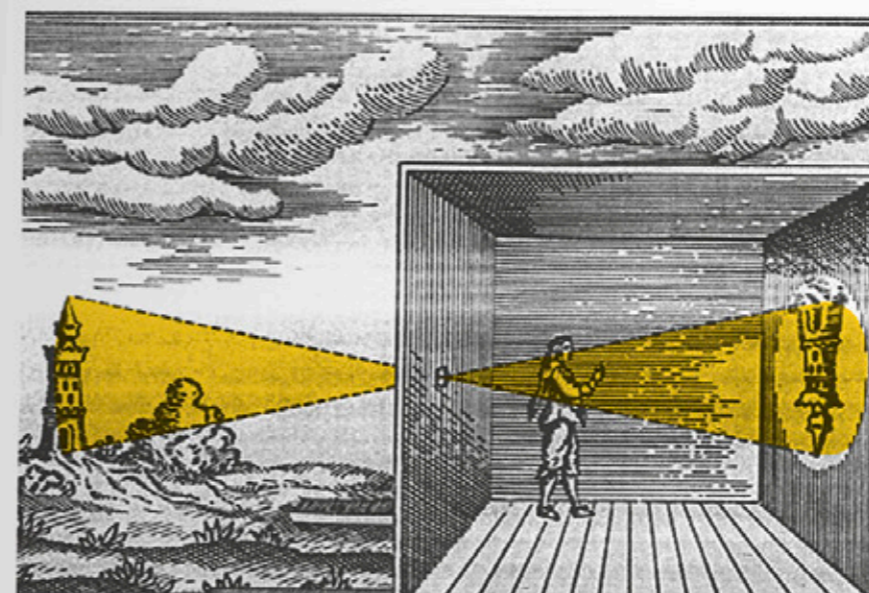

21

E voi quali abiti e oggetti scegliereste per il vostro prezioso dagherrotipo? Pensate a come vorreste essere fotografati per l'unico e solo ritratto che avrete! Vi vestireste da intrepide viaggiatrici? Da contadini newyorkesi? O da cercatori d'oro? Pensateci su!

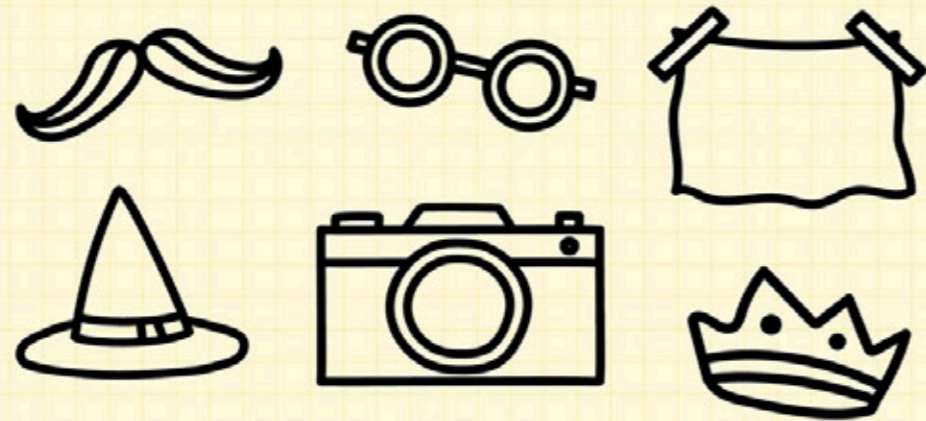

Ecco cosa vi servirà:

- stanza o spazio aperto da usare come studio
- lenzuolo per il fondale

- travestimenti
- macchina fotografica o smartphone
- assistente per scattare

64

Una volta pronti, mettetevi di fronte allo sfondo che avete scelto, che sia un lenzuolo bianco o una tenda decorata...
Ricordate di impostare lo scatto su un tempo di posa lungo (1/4, 1/2 secondo o 2 secondi) per provare il vero brivido della posa ottocentesca!
Sembra poco ma... riuscirete a stare fermi?
Alla fine scegliete soltanto una delle diverse prove fatte: in quest'epoca ogni scatto ha un costo elevatissimo!
Incollatelo, se volete, su questa pagina.



65

Le vostre parole, ragazzi, mi ispirano, siete decisamente più fantasiosi dei miei contemporanei.

**A MOLTI ARTISTI DICONO
CHE NON VANNO BENE LE COSE CHE FANNO...
NON SONO MOLTO LIBERI IN VERITÀ!**

Possiedo diversi manuali di fotografia, pieni di istruzioni, regole per fare le foto perfette, e ancora regole, regole...
Che noia le regole!

La fotografia è amata per la sua precisione, ecco perché le mie opere sono considerate degli errori, delle immagini fatte male. Forse nella vostra epoca saranno apprezzate di più!

**PUOI FARE QUALUNQUE COSA SECONDO
ME PER ALLARGARE I LIMITI DELLA FOTOGRAFIA...
BISOGNA FARE QUALCOSA DI PIÙ ORIGINALE!**



Giusto, sono le imperfezioni a rendere uniche le mie fotografie! A volte l' "errore" avviene al momento dello scatto, in altri casi le immagini vengono modificate dopo.

Sono un'artista
incompresa...

Il negativo può essere graffiato o rovinato nella camera oscura. I pittorialisti più estremi addirittura distruggono il negativo dopo aver stampato la fotografia, per assicurarsi che la stampa sia unica e irripetibile!

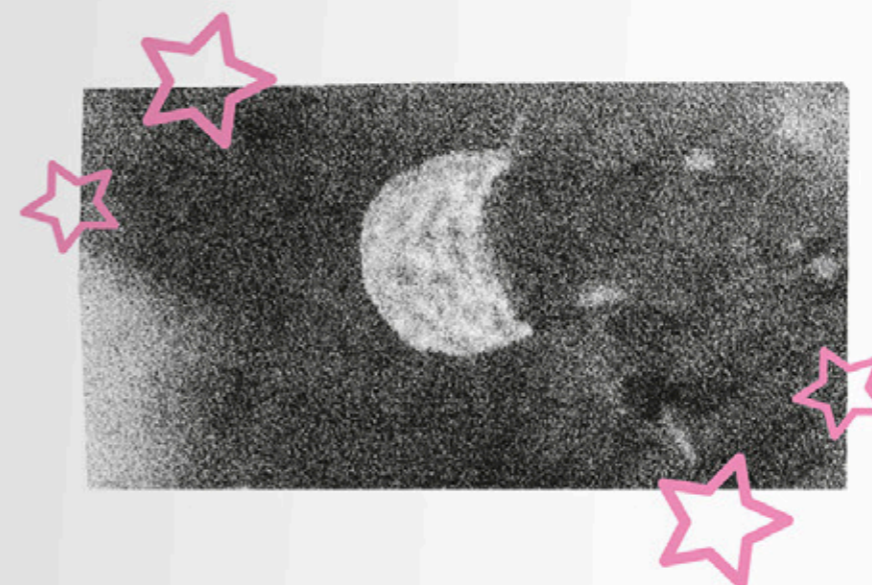

**PER VOI È COME UN LAVORO,
ANDARE AVANTI E SCOPRIRE SEMPRE PIÙ COSE
SULLA FOTOGRAFIA E SULL'ARTE!**

Voglio che le mie fotografie esprimano delle emozioni...

125

SCHERZI FOTOGRAFICI: NASCE IL FOTO- MONTAGGIO



Ciao a tutti! Mi chiamo **Oscar Gustave Rejlander** e vengo dalla Svezia. Sono un artista attratto dalle novità! Ho utilizzato la fotografia come aiuto per realizzare i miei dipinti, in un corso accelerato di un solo pomeriggio pensavo di aver capito tutto. Ma non è così!

Ho scoperto che la **fotografia può essere una grandissima forma d'arte con cui raccontare il mio pensiero**. Vi mostro subito un autoritratto.

EHI, MA COME FANNO A ESSERE DUE DIVERSI MOMENTI? HANNO LA BARBA UGUALE! SEMBRANO GEMELLI O FRATELLI. PERÒ NON SAPIAMO SE QUELLO COL CAPPELLO È PELATO, PERCHÉ NON SI VEDE.



**HAI FATTO UN DOPPIAGGIO
E L'HAI ATTACCATO CON GLI EFFETTI SPECIALI!**

**UNA COSA MI SEMBRA UN PO' STRANA: QUELLE SONO
LA STESSA PERSONA, C'È IL PAVIMENTO UGUALE, SONO
PIÙ O MENO NELLO STESSO POSTO!**



Oscar Gustave Rejlander, *Rejlander Introduces Rejlander the Volunteer* ("Rejlander presenta il volontario Rejlander"), 1871.



**Eh eh... vi ho fatto un bello scherzo.
Perché in realtà in questa foto sono sempre io!**

137

Sea Routes

Stories of water and dry land

written by Pino Pace, illustrated by Allegra Agliardi



168 x 230 mm – hardback

190 p.

22 €

WORLDWIDE RIGHTS AVAILABLE

publishing date

August 2023

Navigation didn't begin when a human being saw a floating trunk, but rather when he climbed on top of it and realized it could still float. Then he got himself another trunk as a paddle and looked for a place to go. So much water has flowed under the bridge since then, and so many inventions took place around that piece of wood! The raft, the boat, the sail, the wheel and then the ship, the compass, the astrolabe... Navigation has become one of the fastest and most efficient ways to travel, in order to get to know the world and conquer it. The sea and the oceans turned into routes for merchants and adventurers who would invent new roads and routes out of their love for adventure, for greed, to pursue freedom or just to escape. In this book, enhanced by supplementary worksheets, depictions, itineraries and explanatory charts, Allegra Agliardi and Pino Pace illustrate

untraced routes hit by storms and blessed by calm seas, recount stories of brave men, visionaries, saints and criminals, tell tales of extraordinary encounters, hops between two lands that could last minutes, months, years or a whole life...

Allegra Agliardi is an Italian illustrator and graphic designer. In 2009 she was awarded as young illustrator of the year within the Illustration Festival based in Pavia, while the following year she joined the group called "Illustrazioni in corso". Among the latest books she illustrated are worth mentioning Parole per la testa! Da dove arrivano i modi di dire? (Feltrinelli, 2021, with Donatella Bisutti) and Merlino (LupoGuido, 2022).

Pino Pace, who graduated from DAMS in Bologna, published more than forty books: tales, novels and poems' collections, almost all for kids and children, many of which have been translated abroad. He's a founding member of ICWA (Italian Children's Writers Association) and the coordinator of the Turin based fiction festival for kids called "Matota, difficult matters put simply", which reached its third edition.



For those who just can't settle
for the discovery of the Americas

~~~~~

A shelfmate to Judith Schalansky's  
"Atlas of Remote Islands" and  
Aleksandra Mizielińska and Daniel  
Mizielinski's "Maps."

~~~~~

All of life on Earth
comes from the sea.

~~~~~

From the voyages of plants  
and animals to literary journeys,  
from cargo-laden containers  
to the routes of migrants: humanity's  
story told through sea travels.

---

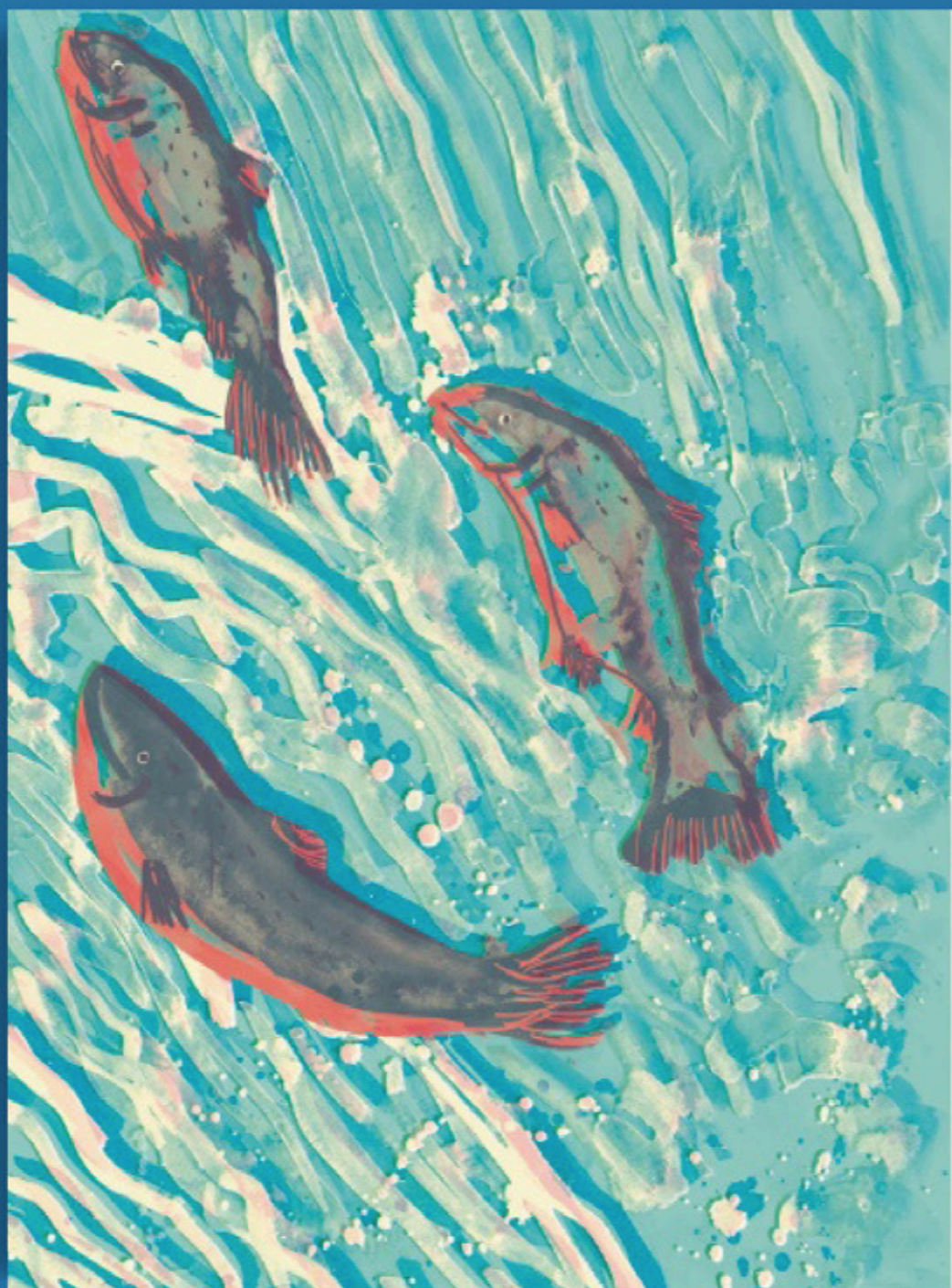

## TABLE OF CONTENTS

|                           |     |
|---------------------------|-----|
| <b>ROUTES OF ANIMALS</b>  | 5   |
| <b>ROUTES OF PLANTS</b>   | 15  |
| <b>POLYNESIAN ROUTES</b>  | 25  |
| <b>COMMERCIAL ROUTES</b>  | 35  |
| <b>ROUTES OF PIONEERS</b> | 47  |
| <b>ROUTES OF SLAVES</b>   | 58  |
| <b>LITERARY ROUTES</b>    | 73  |
| <b>ROUTES OF MIGRANTS</b> | 123 |
| <b>IMAGINARY ROUTES</b>   | 144 |
| <b>ROUTES FOR ONE</b>     | 150 |



## POLYNESIAN ROUTES

### THE WORLD IS MADE OF WATER



Ours is a big planet. Throughout centuries and millenniums, gathering its shape and dimensions was never easy for human beings.

There were men and women, born in lands far away from the sea, who would live generation after generation without seeing or even imagining it. For them the world was made of mountains, plains, deserts, water from rivers, from lakes and from swamps.

There were also men and women who would pass down for generations the belief that the world was an unlimited expanse of salt water, with dry land as an exception. But, like any other man, they needed soil and freshwater to live. Among them there were the Polynesians.

The human colonization of the countless islands scattered within the Pacific Ocean probably started during the Neolithic Age, a couple of thousands years ago. From the

South-East of Asia – currently Vietnam, Taiwan and mainland China – prehistoric people began visiting and occupying bigger islands such as Borneo, Sulawesi, Guinea and the Moluccas archipelago.

Natural disasters, wars, dryness and plagues forced them to set sail and find new lands to colonize. But, besides the need, they were undoubtedly moved by the absolutely human trait of venturing beyond the line of the horizon and towards the next island.

Back then, navigation – in Europe as well as in the rest of the world – was mainly seen as crossing and descending rivers and lakes, or coasting the sea shores, without ever losing sight of the dryland. On the contrary those people, natural born boatmen, would face hundreds of miles in open sea. They were men who could assemble efficient weapons, ships and shelters, who

SEA ROUTES

5

Polynesian routes

mastered agriculture and stockbreeding as well as fishing. Some of them, ancestors of the present Australian aboriginals, landed on an immense continent in favorable conditions and quit sailing.

The others, instead – by going from one island to another, from archipelago to archipelago – colonized most of the Pacific Ocean and gave birth to a civilization and a culture: the **Lapitas**.

By the XI century BC the Lapitas had settled in those geographic areas called Melanesi, Micronesia and Polinesia pushing themselves – within the boreal hemisphere – up to the Hawaii archipelago and Aotearoa (nowadays it's called New Zealand), roughly in 1200 AD.

### WHEN KUPE LEFT HAWAIIKI

Polynesian traditions were handed down by word of mouth throughout the centuries, with every storyteller adding details and elements depending on their flair or imagination. One of the essential myths is the legend of explorer Kupe, who sailed from Hawaii – the fabulous place from where all Polynesians came from – and was led by an octopus to disembark on Aotearoa, the Maori word for New Zealand.

Perhaps when Polynesians reached the archipelago they would later call Hawaii, under a sky – the boreal one – they didn't know, they must have thought they had returned to their homeland, the legendary Hawaii.



### VA'A: THE POLYNESIAN CANOE

The Polynesian canoe was a long and slim hull, with a floating outrigger flanking sideways. The whole boat was made of wood, with every part welded together with strings made from coconut fibres. The va'a was an extraordinarily light boat, equipped with oars and often a triangle-shaped sail, which featured a poor draught (the draught is the hull section which stays underwater). The va'a used to glide on the sea surface, an approach to navigation in some ways opposite to the western and Asian ones, with their very heavy hulls and high draughts, "wedged" deep in the sea depths.

Used for fishing and all kinds of trades between the islands, small fleets of va'a's would ven-

ture in search of new lands. Many of these explorers, taken off-guard by storms or lost in the immensity of the ocean, never came back. But the ones who did return to their islands, like explorer bees, set up trades and sometimes made way for exoduses of whole communities. That's why Polynesians started building big catamarans with two hulls, capable of carrying supplies, tools and dozens of people, including women and children.



### THE FARTHEST ISLAND: RAPA NUI

Rapa Nui, or Isla de Pascua, one of the most isolated places on the planet, doesn't belong to any archipelago and was discovered around 900 AD by the mythical Hotu Matu'a. The Lapita adventurer – maybe by chance, driven by favourable streams – brought a group of men and women (most probably coming from the Marquesas islands, currently known as the French Territoires d'Outremer) to Rapa Nui, after a journey of almost two thousand miles in the open sea.

The descendents kept passing down these explorers' deeds even when they had lost the habit and maybe the aptitude for navigation. The island was rich in natural resources, and was surrounded just by sea for thousands of miles. The gigantic mohais, the impressive stone heads, vouch for the advancement those men and women – whom we know very little about – had achieved.





## UN IMMENSO LABORATORIO

Grande mare o oceano in miniatura, il Mediterraneo è un bacino denso di storie, di misteri, di lingue ed etnie, di rotte e confini. Uno snodo tra Settentrione e Meridione, tra Oriente e Occidente: sulle sue rive popoli, lingue, culture, religioni si sono incontrati, scontrati e mescolati, e hanno forgiato una parte del mondo così come la conosciamo. Le sue acque hanno visto invasioni, deportazioni, migrazioni. Mille e mille rotte si sono incrociate e sovrapposte, sono state dimenticate e riscoperte.

Il Mediterraneo oggi è un mare modesto: servono pochi minuti per attraversarlo in aereo. Nell'antichità ci volevano giorni e settimane, in balia dei venti e delle tempeste. Le rotte non erano quasi mai drit-

te: i marinai dovevano imparare a seguire le coste e le stagioni, obbedire ai venti e alle correnti, fidarsi del sentito dire e affidarsi a un sesto senso simile alla bussola biologica degli animali migratori. Molti si perdevano, ma erano di più quelli che tornavano a raccontare, per poi partire di nuovo.

Il Mediterraneo respira con il fiato dei due grandi vicini: tra primavera ed estate comanda il deserto del Sahara, che porta sole e poca pioggia; in autunno e inverno ci si affida alle correnti fredde dell'oceano Atlantico, con piogge e neve che rinfre-

Rotte del Mediterraneo 29



## I VICHINGHI E LE TERRE DEI GHIACCI

Tra l'VIII e il IX secolo d.C. il popolo guerriero dei vichinghi cominciò a colonizzare le terre disabitate e a predare città, paesi e monasteri nel Mare del Nord e nel Baltico; l'Inghilterra e la Francia si spinsero fino nel Mediterraneo.

L'Islanda era stata scoperta dai vichinghi, ed era disabitata. A metà del IX secolo d.C. Hrafna-Flóki Vilgerðarson imbarcò parenti, amici e qualche pecora sui suoi drakkar e partì dalla Norvegia. La sua storia è raccontata in un manoscritto islandese, il *Landnámabók* (Il libro dell'Insediamento). Hrafna-Flóki (*Hafna* vuol dire corvo) passò dalle isole Shetland dove una delle sue figlie morì; alle Fær Øer un'altra figlia si sposò e Flóki prese con sé tre corvi (una vicenda che ricorda molto quella

di Noè e del diluvio universale). Passarono altri giorni di navigazione e quando pensava di essere vicino all'Islanda liberò il primo corvo che tornò indietro. Il secondo corvo, liberato tempo dopo, fece un giro e si posò di nuovo sulla nave. Il terzo sfrecciò di fronte a loro e non tornò. Floki lo seguì e trovò quella che chiamò *Islanda*, la Terra del Ghiaccio.



### IL DRAKKAR

Non era per niente comoda, ma il suo lavoro lo faceva bene: la nave dei vichinghi, perfezionata nel Medioevo, era lunga più di venti metri e affilata come una spada. Spesso aveva una poppa: la testa di un mostro o di un drago, così che chi la incontrava non si facesse illusioni. Su un drakkar una trentina di marinai/esploratori/pirati arrivavano molto vicino alle rive o risalivano i

fiumi. Portati a secco, i drakkar erano in grado di riprendere il mare immediatamente: non era necessario girarlo, la poppa diventava prua in base alle necessità. All'interno dello scafo doveva starci tutto: uomini, provviste, acqua, armi, un albero con vela, e tanti remi. La nave vichinga non aveva ponte né consentiva alcun tipo di riparo dalla pioggia e dal gelo, se non teli e pellicce.



## LA TERRA DEL VINO

La Saga dei Groenlandesi e la Saga di Erik il Rosso narrano la colonizzazione vichinga della Groenlandia e del Nord America, intorno all'anno Mille. Può darsi che i vichinghi approfittarono del riscaldamento climatico della Terra, che rese più agevole navigare nei mari ghiacciati dell'Artico.

Allontanato per aver ucciso due uomini, Erik il Rosso salpò dall'Islanda con la moglie Thjodhild e fece rotta verso le terre sconosciute a occidente, di cui aveva sentito parlare.

Dopo mesi di esplorazione – in balia di tempeste, nebbia, iceberg e Inuit, senza possibilità di orientarsi – tornò in Islanda. Riportò denti di narvalo (in Europa si pensava fossero i corni dell'unicorno), raccontò di trichechi, orsi polari, terre verdi da colonizzare. Forse esagerò un po': voleva tornarci, e aveva bisogno di volontari.

Altri esploratori lo seguirono, ma secondo le saghe furono i figli di Erik e Thjodhild a consolidare la presenza vichinga nelle nuove terre.

Il figlio Leif si spinse ancora più a occidente, dove le coste piegavano verso il Meridione. In inverno si fermò in una terra dal clima mite e dalle

notti meno lunghe. Ci cresceva l'uva, per questo Leif la chiamò *Vinland*, Terra del Vino.

In primavera tornò in Groenlandia e raccontò tutto al fratello Thorvald che salpò con un equipaggio nutrito. Voleva fondare una colonia. Ma i nativi di *Vinland* (per i vichinghi erano *Skræling* "miserabili") li presero a frecciate e uccisero Thorvald. Un altro fratello, Thorstein, non trovò la rotta e morì. La sorella Freydis s'accordò con marinai islandesi, ma quando arrivò a *Vinland* li uccise. Rientrata in Groenlandia, Leif scoprì il tradimento della sorella e la punì...

Il viaggio era lungo, i nativi ostili, forse il clima tornò rigido, e presto la rotta per *Vinland* fu raccontata solo nelle saghe. Nel XX secolo ad Anse aux Meadows, sull'isola canadese di Terranova, si scoprirono i resti di un antico villaggio. Pareva un insediamento indigeno, ma utensili, abitazioni e officine per costruire navi erano simili a quelle vichinghe della stessa epoca. È probabile che si trattasse della *Vinland* di Leif Erikson, il primo europeo ad arrivare nel continente americano, circa quattro secoli prima di Cristoforo Colombo.

# Street Trees

## How to live with the urban green

Sara Filippi Plotegher

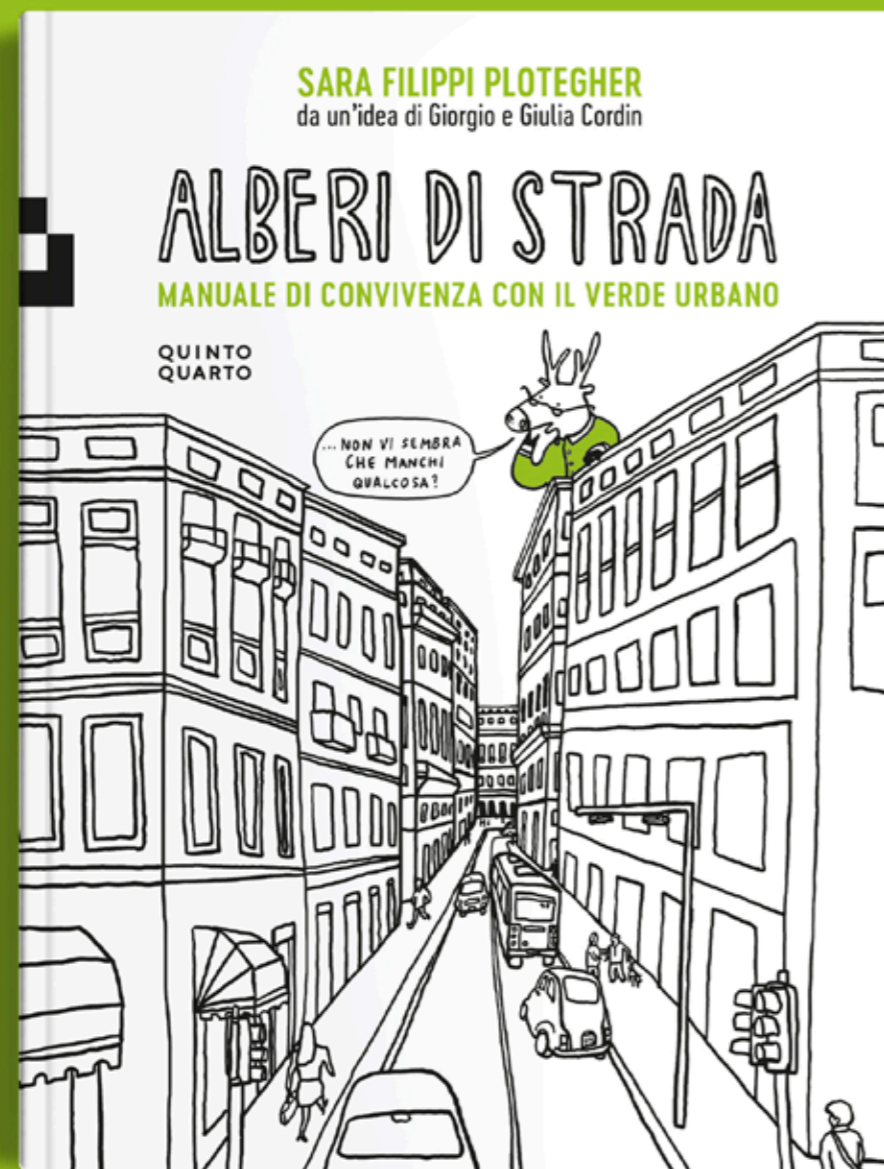

160 x 212 mm – paperback  
128 p.  
16 €

WORLDWIDE RIGHTS AVAILABLE

publishing date  
May 2023

### Urban forest bathing

In the beginning, there was the woods. Urban greenery isn't a mere adornment, nor is it a tool in the hands of humans. It must be known just as we know our neighbors, and it should be respected and protected like any living being.

Sara Filippi Plotegher, a cartoonist and scientific communicator, embarks on an encyclopedic journey to discover the characteristics, needs, and functions of trees in the city fabric. She shows us how the relationship between humans and plants can be fruitful and vastly different from what it has been so far.

Do you know what mycorrhizae are, the root fungi? Their mycelium connects the roots of trees, allowing them

to communicate and assist each other. That's why one should think twice before planting isolated trees. And did you know that asphalt doesn't allow the ground beneath to nourish itself properly with water and oxygen? Sometimes, it would be enough to use porous materials or raise the pavement... or even design green spaces upstream while considering the needs of the greenery. When you look at that tree near your house, fearing it might fall disastrously on the roof, remember that improper pruning could be even more dangerous.

Harmonious coexistence between humans and plants is possible: all it takes is getting to know each other, listening, and respecting one another.



The future is green, but not necessarily far from city walls urbane.

From root to crown, an illustrated guide to the world's oldest and largest living beings, because planting trees isn't enough; it must be done with awareness and in full respect of their uniqueness.

“Like the pines of Rome, life doesn't break them...”

How, when, and why trees made their way into our cities.

IN PRINCIPIO  
ERA IL BOSCO

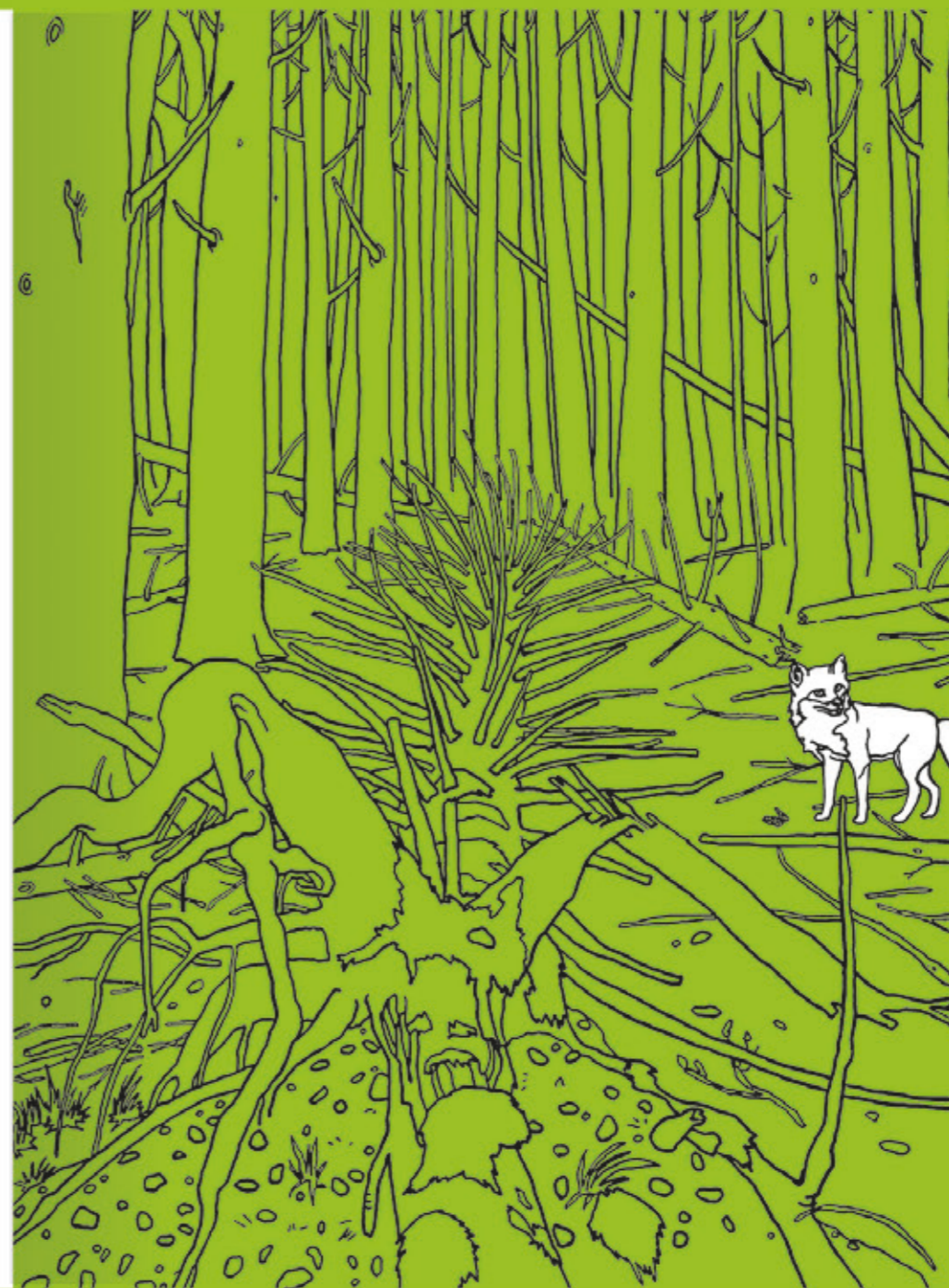



il verde e l'abbassamento delle temperature

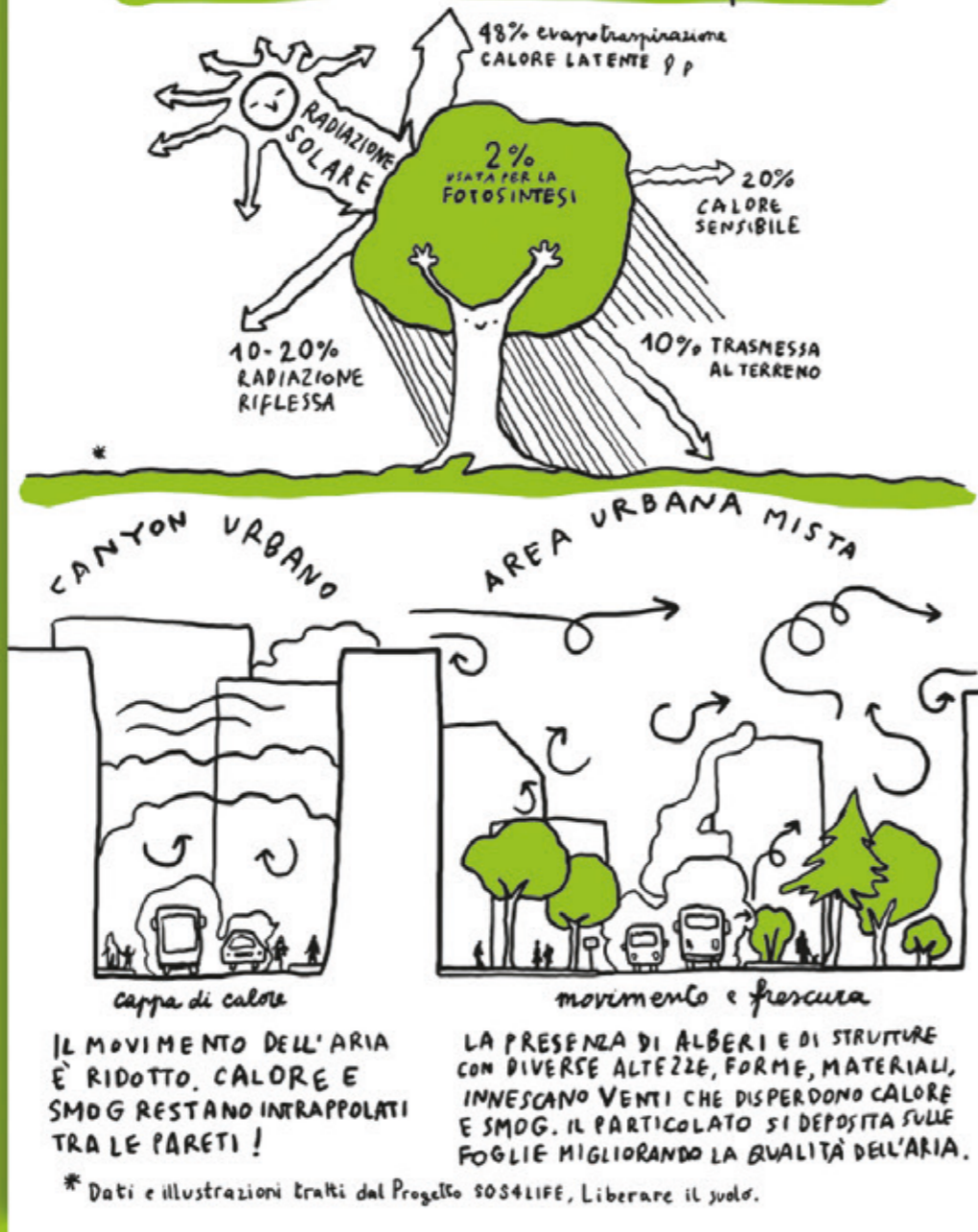



114

LA LEGGENDA NARRA CHE MOLTI VIALI DI CITTÀ  
SIANO OMBREGGIATI DA PLATANI GRAZIE ALLA  
PECULIARE SENSIBILITÀ DI...  
NAPOLEONE BONAPARTE

LI FACEVA PIANTARE OVUNQUE... IN ONORE DI  
BATTAGLIE MILITARI... MA ANCHE DI CUORE ♡



PIANTATELO  
QUI!



NAPOLEONE BONAPARTE

P  
L  
A  
T  
A  
N  
U  
S  
O  
R  
I  
E  
N  
T  
A  
L  
I  
S



IL PLATANO È UN ALBERO MAESTOSO, GIÀ  
AMATO NELL'ANTICA GRECIA! PERSINO SOCRATE  
DISCUTE D'AMORE CON FEDRO ALLA SUA OMBRA!

OGGI È MOLTO DIFFUSO NELLE CITTÀ PERCHÉ  
SOPPORTA BENE LE POTATURE E... LO SMOG!

LE SPECIE DI PLATANO PIÙ DIFFUSE NELLE  
CITTÀ DEL MONDO SONO:  
PLATANO ORIENTALIS  
PLATANO ACERIFOLIA  
PLATANO OCCIDENTALIS.



# Slow Cooker

## Secrets and recipes to cook slowly

**NEW EXPANDED EDITION**

Claudio Cesarano, Andrea D'Ippolito,  
Daniele Giacomini, Diego Marsicano



170 x 240 mm – paperback

136 p.

18 €

WORLDWIDE RIGHTS AVAILABLE

publishing date

June 2023



### At a snail's pace...

There are three types of people: those who will read this book because they own a Slow Cooker, those who will buy a Slow Cooker after reading this book, and those who already have a Slow Cooker and will acquire two, three, four more...

The Slow Cooker is a pot, but even more so, it's a philosophy of food: our grandmothers knew this well, using a primitive ceramic version of it directly in the fireplace. The folks behind the Slow Cooker Recipes blog know it too, as they've dedicated themselves to experimenting with dishes made from vegetables, meat, fish, legumes, and desserts.

Slow cooking caters to all the characteristics of ingredients, consumes very little energy, and frees us from the anxiety of keeping stovetops on. In this expanded edition, you'll find the history, secrets for proper maintenance, and 20 new recipes that will make you love this marvelous vintage item even more.

*Ricette Slow Cooker (Claudio Cesarano, Andrea D'Ippolito, Daniele Giacomini, Diego Marsicano) is the first Italian collective committed to slow cooking. It's made up of a group of colleagues/friends, rigorous as engineers and imaginative as graphic designers, who poured onto their blog – Google's first result – all the experience gathered in years of experiments and practice on the counter.*

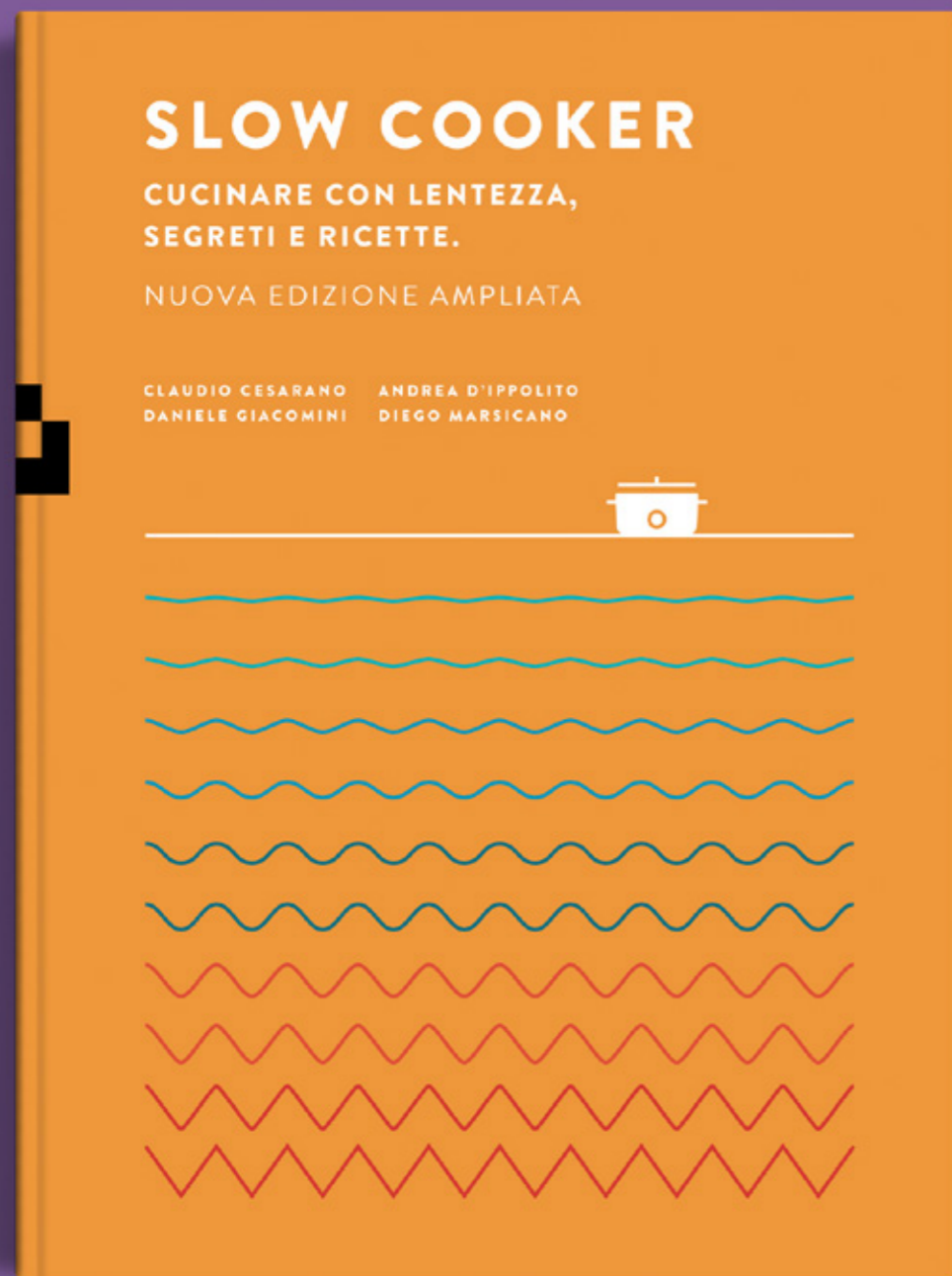

---

**NEW EXPANDED  
EDITION.**

---

**SOLD OVER  
20.000  
COPIES.**

---

**THE FIRST  
ILLUSTRATED GUIDE  
TO SLOW COOKER!**

---

**FOR LOVERS  
OF SLOW LIVING:  
COOKING HAS NEVER  
BEEN SO RELAXING.**

---

## PUREED SOUP OF LEEKs AND CARROTS

2½ H HIGH - 3,5 L - 4 PEOPLE - EASY



### INGREDIENTS

- 1 pound carrots
- 2 leeks
- 2 potatoes
- 1 garlic clove
- 1 ¼ cup water
- 1 spoon lemon juice
- 2 spoons of extra virgin olive oil
- salt and pepper to taste

*There's this little human being in your house who went from eating everything to shunt vegetables aside. You did try your best with flower-shaped potatoes and bear-like carrots, but even that doesn't seem to amuse your son anymore. It's time to offer him a pureed soup: there'll be nothing to nibble, nothing to thrust away from the dish. You're short of time and won't be home before evening? Don't worry: the Slow Cooker will do the job for you.*

### METHOD

Peel off the potatoes and the carrots, cut the carrots to pieces, slice the leek removing the outer layer and the harder and more green parts, peel and crumble the garlic. Brown the leeks and the garlic in a frying pan with hot oil; a few minutes later, add the carrots first and later the potatoes, then let it all brown for one more minute.

### SLOW COOKING

Move the ingredients into the Slow Cooker and cover them with 1 ¾ cup of hot water. Cook on High mode for 2 hours and a half. When the cooking time is over and the carrots are tender, blend everything with an immersion blender (or possibly a basic blender), add salt, pepper and the lemon juice. Should it seem too runny, you can boil it for a few minutes. Your pureed soup of leeks and carrots is ready: serve it warm, if possible with crisp croutons.



FROM THE WORLD

## HUNGARIAN GOULASH

5H HIGH - 3,5 L - 4 PEOPLE - MEDIUM



### INGREDIENTS

- 2 pounds beef stew
- 1 green capsicum
- 1 big potato
- 1 big white onion
- 1 tomato
- 1 big carrot
- 1 cup tomato puree
- 2 teaspoons cumin seeds
- 1 ounce sweet paprika
- extra virgin olive oil to taste
- salt and pepper to taste

*The well-known dish dating back to herdsmen was originally a hot soup meant to supply the right amount of calories to the stockmen. It then went through some "urban" alterations until becoming the goulash almost everyone of us is familiar with. It's basically a very spiced stew, on which paprika rules undisputed. In Hungary the goulash is called Pörkölt and is usually served with little flour dumplings called galuska.*

### METHOD

Cut the onion, the carrot, the potato and the tomato into rough pieces, and the capsicum into smaller bits. Cut also the beef meat likewise. Spill the oil into a capacious frying pan, brown the onion, the carrot, the capsicum and half of the cumin seeds. Later on, add the beef meat too and let everything brown on all sides for a few minutes. Eventually add in the sliced tomato. Mix sweet paprika, salt, pepper and the remaining cumin seeds into a cup of tomato puree.

### SLOW COOKING

Move everything into the Slow Cooker. Cover the other ingredients by pouring over the mixture of tomato, spices, salt and pepper. Add the sliced potato and stir gently. Cook on High mode for 5 hours, stirring just once after about 4 hours. Serve the Hungarian goulash warm, according to tradition. Match it with white rice or a tasty bread to mop up your plate!

96



Slow Cooker, utilizzata in modalità Low, consuma come una lampadina. Se però non siete ancora convinti... Seguendo una guida su come calcolare il consumo elettrico di un qualsiasi apparecchio, considerando il costo dell'energia elettrica di un gestore X (0,079 €/Kwh)... e il consumo ipotetico in 8 ore di cottura di una delle nostre Slow Cooker (235W x 8 = 1,880 KWh)... abbiamo fatto questo calcolo:  $0,079€ \times 1,880 \text{ KWh} = 0,14852 €$ .

Se il vostro contratto ha un costo doppio rispetto a quello calcolato, saranno ben 30 i centesimi spesi per una cottura. Ecco quindi il piccolo esborso di denaro che quotidianamente un utilizzatore deve mettere in conto per l'aumento della bolletta!

#### CUCINA SALUTARE

La Slow Cooker può essere anche un prezioso alleato per la vostra forma fisica. L'umidità che si creerà all'interno della pentola renderà superflui i condimenti come olio e burro: il cibo non si brucerà mai!

#### LENTO È MEGLIO

Le ricette che già cucinate abitualmente miglioreranno con la cottura lenta. Il consiglio è quello di usare la modalità Low della Slow Cooker, che cuoce alla temperatura più bassa. Carne tenera, verdure sode e saporite, legumi più digeribili!

#### CUCINA PER PRINCIPIANTI

Per usare la Slow Cooker, non bisogna essere chef esperti: è alla portata di tutti, basterà mettere gli ingredienti in pentola e accendere. Mezz'ora di troppo di cottura? Non c'è niente da temere, non farà grandi danni, non troverete tutto carbonizzato se fate tardi in ufficio o se l'avete dimenticata accesa per un po' più del previsto. È comunque consigliabile impostare il timer se la usate quando siete fuori, o eventualmente comprare una presa temporizzata che spenga la Slow Cooker una volta terminata la cottura.

16

## COMPONENTI

La Slow Cooker, strumento piuttosto semplice, si compone di 3 parti principali: la resistenza, la pentola e il coperchio.



#### COPERCHIO

È a tenuta e generalmente di vetro, accorgimento che permette di guardare all'interno.

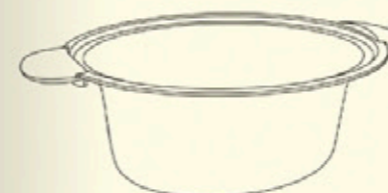

#### PENTOLA

La pentola interna, solitamente di ceramica (ed è così da secoli), viene inserita all'interno del contenitore metallico e garantisce la cottura in umido per la quale la Slow Cooker è così famosa.

Sulla parte esterna del contenitore metallico è presente una manopola con la quale è possibile impostare le due modalità Low o High, oppure mettere in caldo con l'opzione Warm.

**Low:** programma standard, per cotture più lunghe, in media di 6-8 ore.

**High:** programma di cottura più rapido, per cotture più brevi, in media di 4 ore.

**Warm:** programma che consente di mantenere in caldo la pietanza.

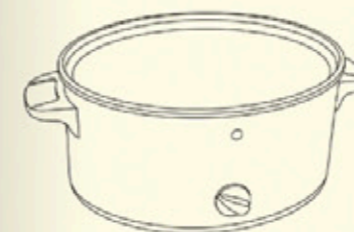

17

SALSE, SUGHI & BRODI

## SALSA GENOVESE

9H LOW E 1H HIGH - 3,5 L - X 5 - FACILE

### INGREDIENTI

- 500 g manzo: lo scamone, ma si adattano bene anche molti altri tagli
- 500 g cipolle ramate
- 1 costa di sedano (50 g circa)
- 1 carota (50 g circa)
- 1 rametto di rosmarino
- 1 bicchiere di brodo di carne
- olio extravergine di oliva q.b.
- sale e pepe q.b.

*La Genovese è un piatto tipico della tradizione napoletana. Un sugo di cipolle e carne la cui origine è incerta: alcuni sostengono sia stata inventata in Campania da cuochi genovesi, altri fanno risalire la sua comparsa al XV secolo, quando nelle bettole del porto di Napoli veniva preparata per sfamare i marinai genovesi, altri ancora ne attribuiscono la paternità a un cuoco, sempre vissuto nel XV secolo, soprannominato "O Genovese".*

### PROCEDIMENTO

Pulite e tritate le cipolle, il sedano e la carota. Tagliate la carne formando dei quadratini di circa 1 cm o poco più. Lasciate soffriggere per 3-4 minuti nell'olio il trito di cipolle, carota e sedano.

### COTTURA SLOW

Trasferite tutto nella Slow Cooker. Aggiungete il sale, il rametto di rosmarino, una spolverata di pepe nero, un bicchiere di brodo. Cuocete in modalità Low per 8 ore. Passate le 8 ore, aprite il coperchio e fate cuocere per un'ora in modalità High senza coperchio, in maniera da far evaporare i liquidi in eccesso. Quest'ultimo passaggio può essere evitato diminuendo il brodo (mezzo bicchiere invece di un bicchiere), ma è preferibile comunque cuocere nel brodo, come da metodo tradizionale, per poi ridurre i liquidi alla fine.

Mescolate bene la Genovese e usatela per condire gli ziti napoletani o i paccheri. Impiattate e spolverate con del parmigiano grattugiato.

34





## PERSICO AL LIMONE

3H LOW - 3,5 L - X 2 - FACILE

### INGREDIENTI

- 500 g filetto di persico
- 1 limone
- farina q.b.
- aneto (o finocchio o altri aromi)
- 1 cucchiaino di olio extravergine di oliva
- sale q.b. (facoltativo)

*Rispetto al merluzzo, il persico rimane più sodo e ha due indubbe qualità: è meno caro e soprattutto è molto saporito. La ricetta è simile a una mugnaia con un po' di limone in più. Se i vostri bambini ne hanno abbastanza di sogliole, provate a introdurre una novità nel menù di pesce: potrebbero stupirvi e farvi sentire degli ottimi chef.*

### PROCEDIMENTO

Tagliate il filetto in due o più pezzi. Infarinare i filetti su tutti i lati (nella ricetta è stata utilizzata la farina di grano saraceno, quindi senza glutine).

Spremete un limone in una ciotola ed emulsionate il succo con un cucchiaino di olio. Aggiungete il sale a piacimento. Se lo avete, unite all'emulsione dei ciuffi di aneto o di finocchio e qualsiasi altro aroma che pensate possa stare bene col pesce. Rimuovete la farina in eccesso dal pesce e irroratelo in modo omogeneo con l'emulsione.

### COTTURA SLOW

Se avete una griglia mettetela sul fondo dalla Slow Cooker per ottenere una cottura simile a quella al vapore. Stendete un foglio di carta forno sul fondo della pentola (o sulla griglietta). Adagiate il persico sopra la carta forno e cuocete per 3 ore in modalità Low. (La carta forno vi sarà utile a fine cottura per tirare fuori il pesce senza che si rompa.)

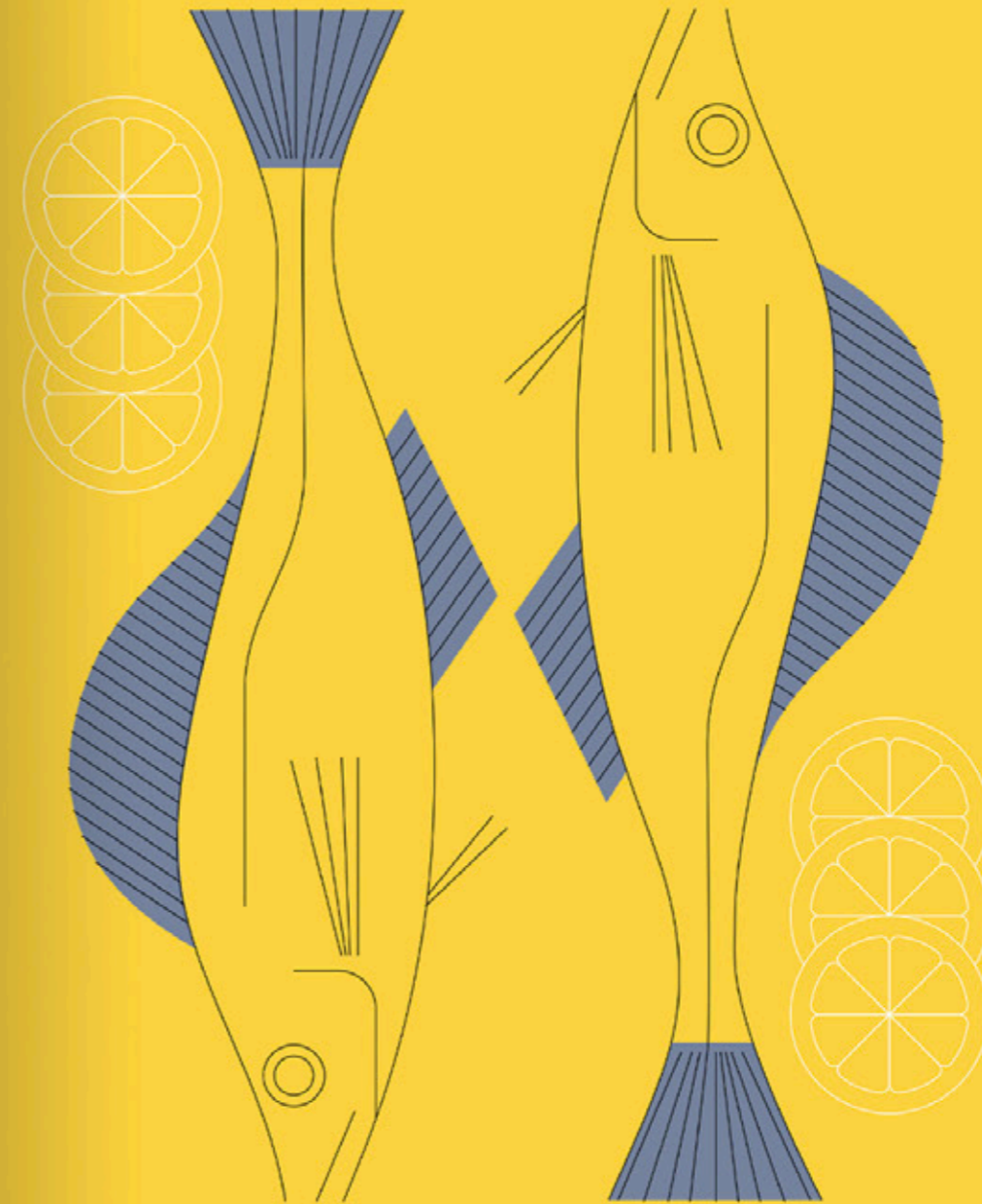

---

# The Catalogue



---

by Quinto Quarto Edizioni





# The Box from Home

Chiara Spinelli



170 x 170 mm – hardback

64 p.

14 €

WORLDWIDE RIGHTS AVAILABLE

publication date

September 2022

## «Goodbye honey, don't waste yourself away!»

It's a common saying: food nourishes the soul. Asking someone if they had lunch means letting them know we care, and we all have a favourite recipe we keep in our hearts, which often belongs to childhood memories and makes us feel at home even when we're far away. But there's a dodge, devised by anyone who lives far from the homeland to feel their hometown's and loved ones' warmth: **the box from home!**

With terse traits and vivid colors, the metaphor par excellence of family warmth and bond to the homeland comes alive throughout the pages: the box from home, a custom with the power (and the magic) of shor-

tening distances and preserving ties beyond time and space. This gentle silent book is an evocative object which stacks up pages and miles felt-tiptoeing, leaving us with the right words to describe the taste of nostalgia.

*Chiara Spinelli is an illustrator and early childhood educator. She graduated from Accademia di Belle Arti in Lecce, then specialized in Design for children at Libera Università in Bolzano. She's currently a freelance working for magazines, publishing houses, agencies and associations, while holding educational workshops. In Bari her works got featured in urban art projects and district promotion and redevelopment. In 2021 she published Il Mare è... (Kuru-muny Edizioni) with Carla Saracino.*

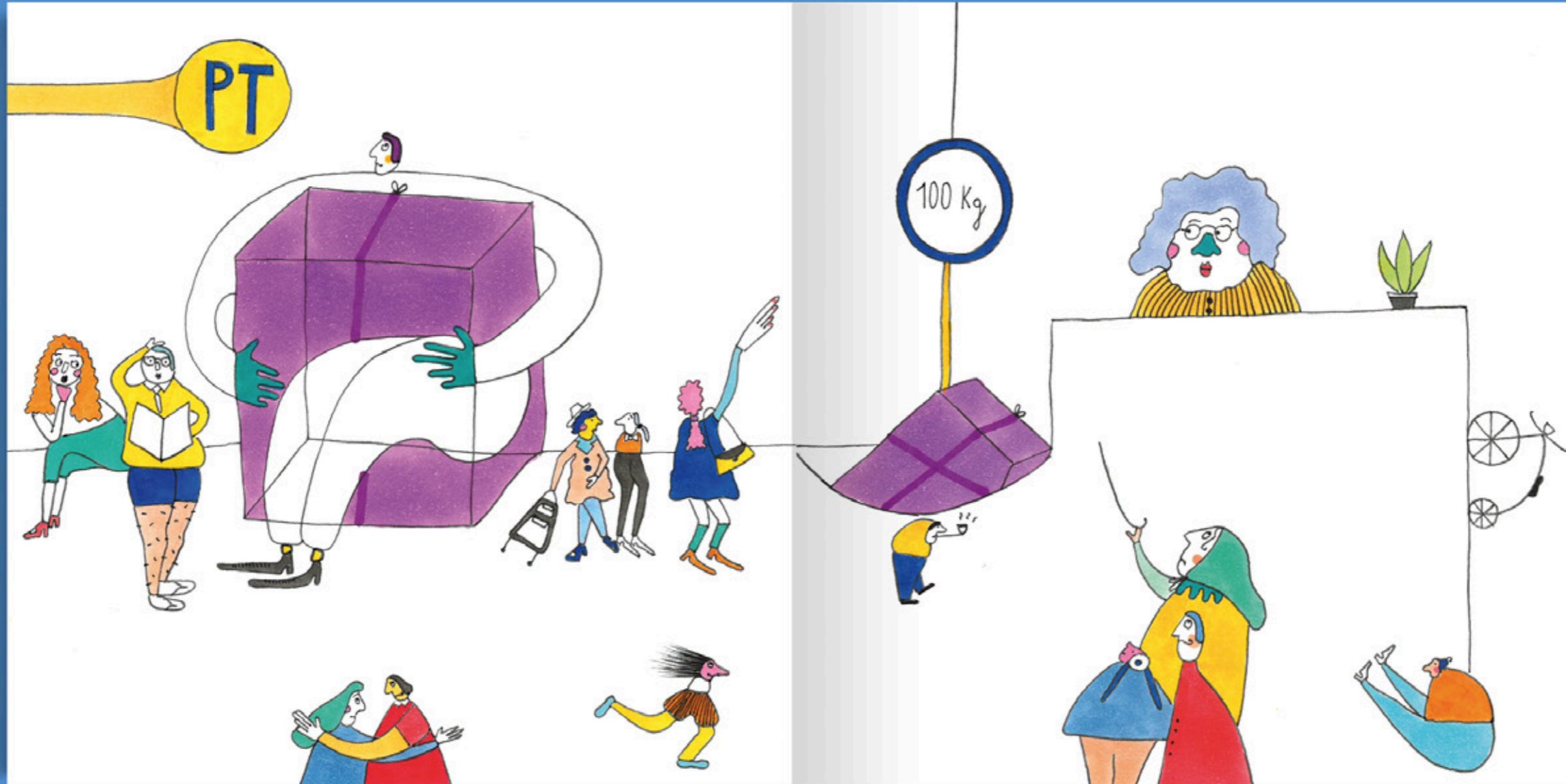

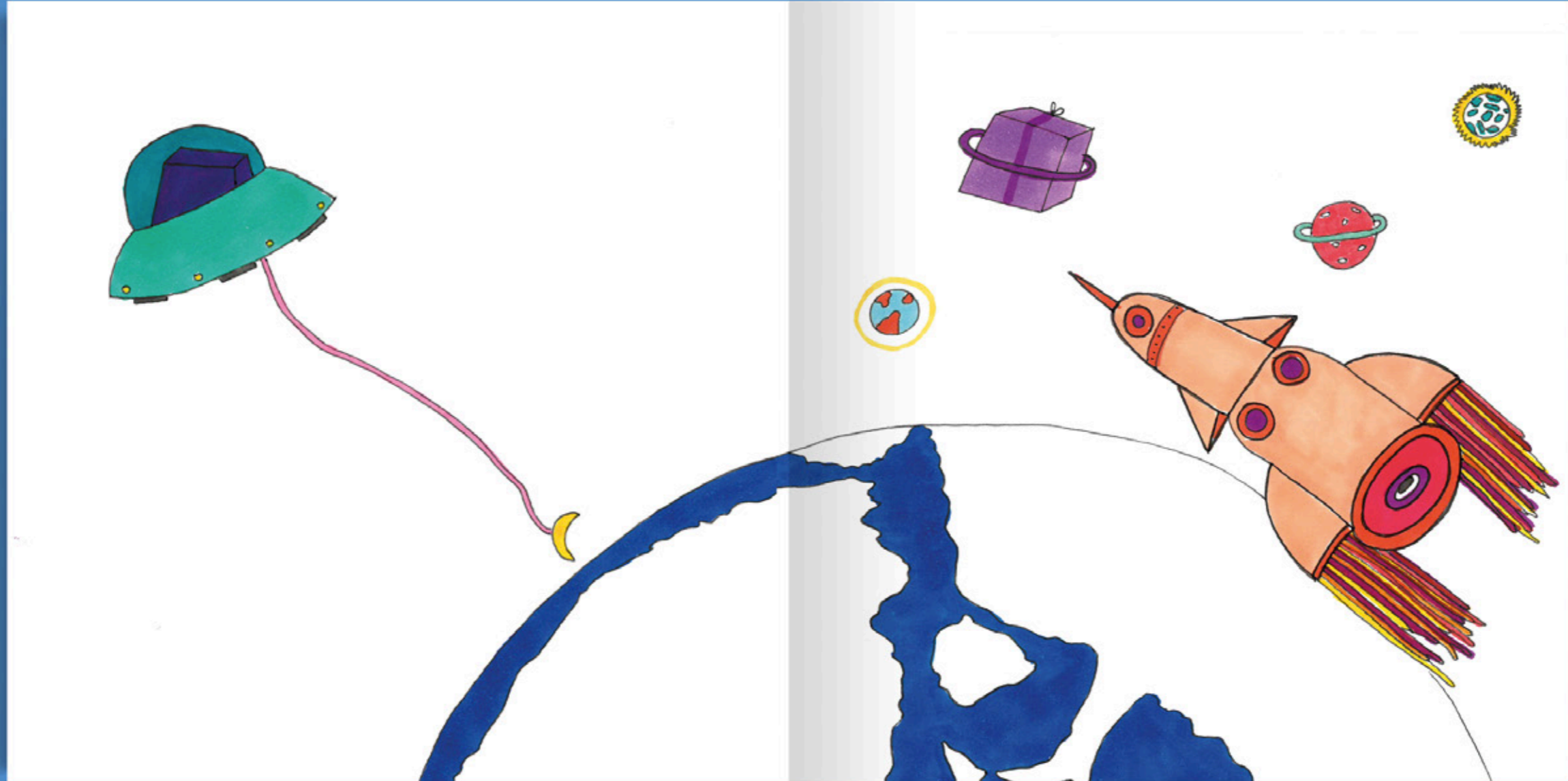



# The Dildo Book

written and illustrated by PAMCOC



170 x 240 mm – hardback

164 p.

22 €

WORLDWIDE RIGHTS AVAILABLE

publication date

April 2022



## It takes all sorts to make a dildo.

Did you know the lithic industry was essential to human sexuality? But, first things first – do you know what the lithic industry is? Yes, we’re talking stones, but don’t be struck, that would be a wrong introduction. The Dildo Book, a fairly long book, deals with the endless ways in which men and women tried their hands at shaping the object of desire: it retraces the dildo’s beginnings and evolutionary phases, lists its materials, depicts human anatomy and unveils technologies and fun facts hiding behind and before such a mysterious (for someone) pleasure tool. Because dildos may be sex toys, but not just that. PAMCOC didn’t write a handbook, an instruction book or the ultimate dildo history: hers is a free tale, the journal of

a step-by-step approach, a collection of information, oddities, irony, questions (and sometimes answers) for everyone everywhere. But it’s first and foremost an art book.

*PAMCOC is Pamela Cocconi. She used to sketch since she was too little to remember, and enjoys playing with words. Her work goes with the flow of all the things that cross her mind, with light profoundness and deep levity. Linguistic mastery, exuberance and praise of mistakes are the distinguishing figures of her importunate and uninhibited spirit.*

*disegnolecose.it*

INTRODUCTION  
~~TO~~  
OF THE DILDO

Introduction: never a word was so spot-on to introduce the following pages. This is an introduction to an introduction, and it should be clear by now that it's not thought as an ordinary word, but rather as one targeted to the object at issue. It's an introduction to something that usually gets introduced. You can't introduce more than that.

It's an introduction that plunges its roots into man's evolution history, because between the discovery of fire and the invention of wheel all sorts of things happened. The lithic industry\* in particular gave birth to an unusual object, intended to make the news throughout the centuries. Even before learning to write, as a matter of fact, our ancestors would carve dildos.

8

DROP  
WHAT  
YOU'RE  
DOING!

ONE THING AT A TIME

\* WHAT ON EARTH IS  
THE LITHIC INDUSTRY?

Within the scope of prehistoric archaeology, the lithic industry is defined as the entirety of rocky objects manufactured by man from pebbles intentionally altered.

Probably the most ancient technology ever consisted in breaking stones to get tools suitable for digging, cutting, severing, piercing and... giving pleasure.

9

SOME EXAMPLES  
OF LITHIC INDUSTRY  
ARTIFACTS



AMYGDALA



BIFACE



KNIFE



SCRAPER  
ON PEBBLE

10



SCRAPER



CHOPPER



DRILL



HOLE-PUNCHER



DILDO

11

## THE MINIMALISTS

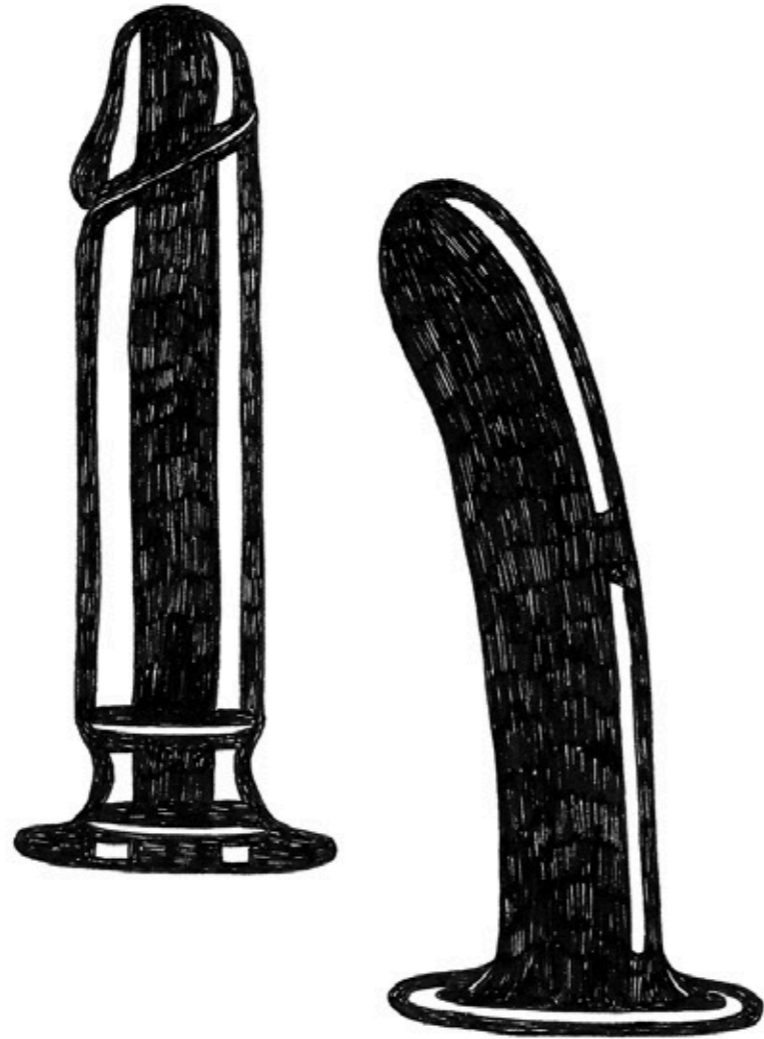

48

## THE PUNKS

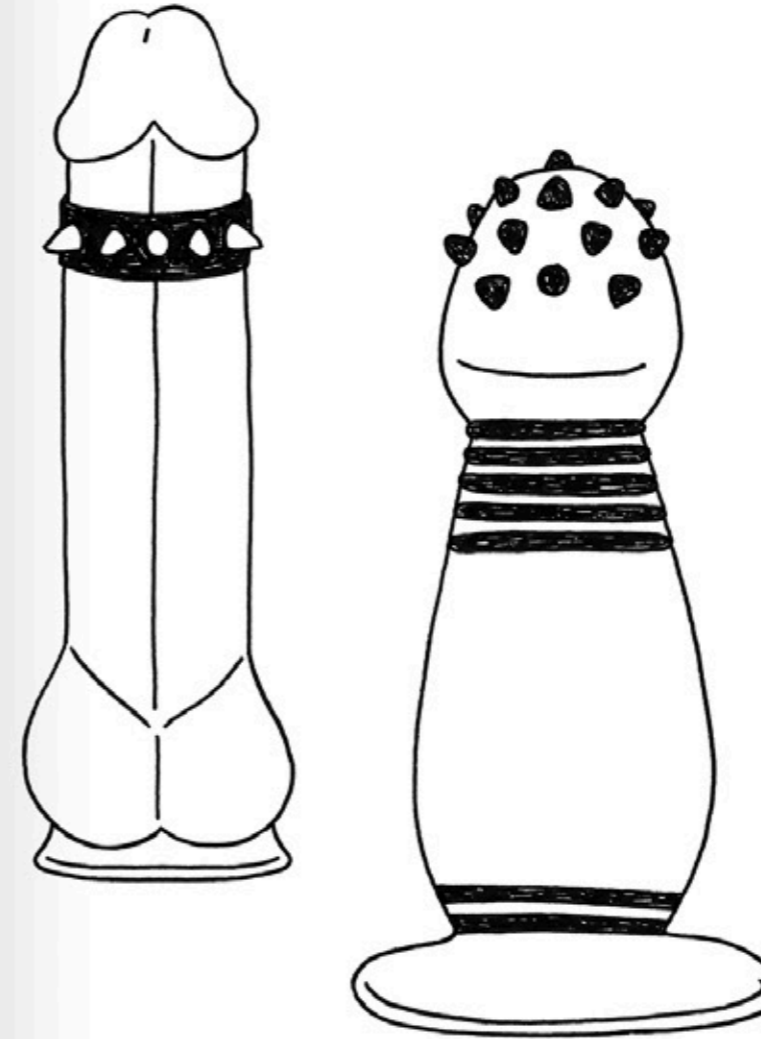

49



MY PHONE  
IS  
VIBRATING



(OR "CALL ME BY  
YOUR DILDO")

54

THE DILDO SAURS

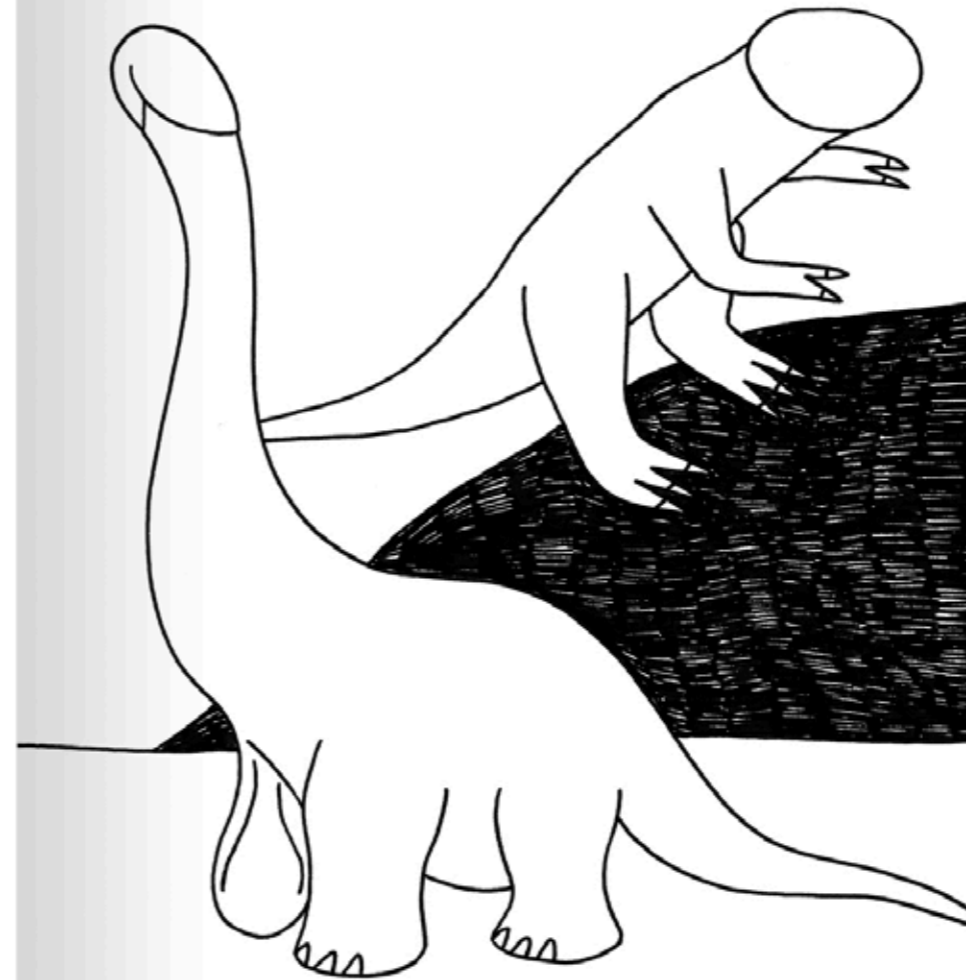

55

A HISTORY OF  
CONTEMPORARY CENSORSHIP...

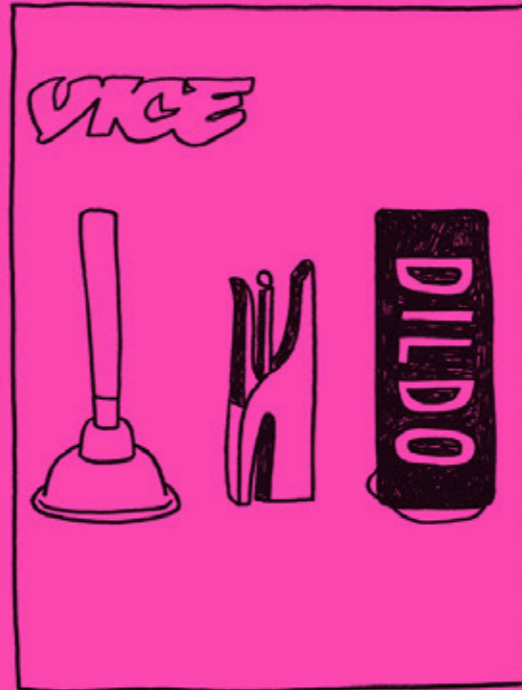

During Easter 2012 Maurizio Cattelan, on the front cover of *Vice*'s special edition labeled "The Holy Trinity", stated once again his love for religious iconography. Together with Pierpaolo Ferrari, the artist showed three objects: a sink plunger (the Father), a stapler (the Son) and a dildo (the Holy Spirit). Way too much to bear for the US Postal Service, which censored the image and commanded that the very true-to-life third wheel should be covered on each copy by a label stating DILDO in block letters.

62

...AND AN UNCENSORED STORY  
FROM ANCIENT GREECE



Would a vase like this suit your current living room? No matter what you answer, Greeks would have said yes without the shadow of a doubt! Already in 500 BC dildos were exported throughout the Mediterranean from the harbour of Miletos. The artisanal production of the time boasted a vast inventory of dildos and other sex toys, since when it came to eroticism there were no taboos.

63

WELCOME TO THE  
CONTEMPORARY  
ART GALLERY

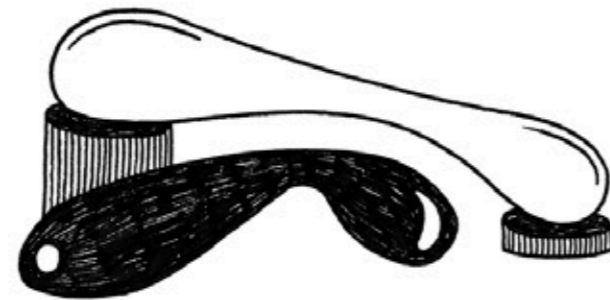
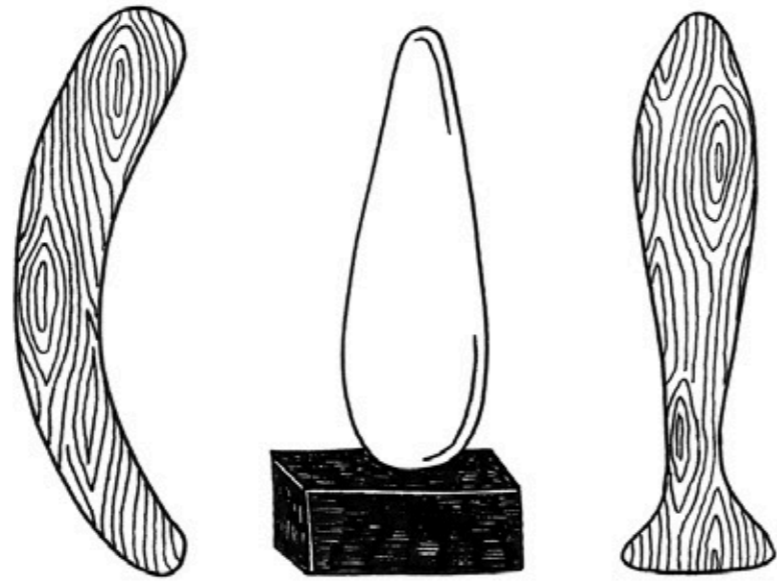

74

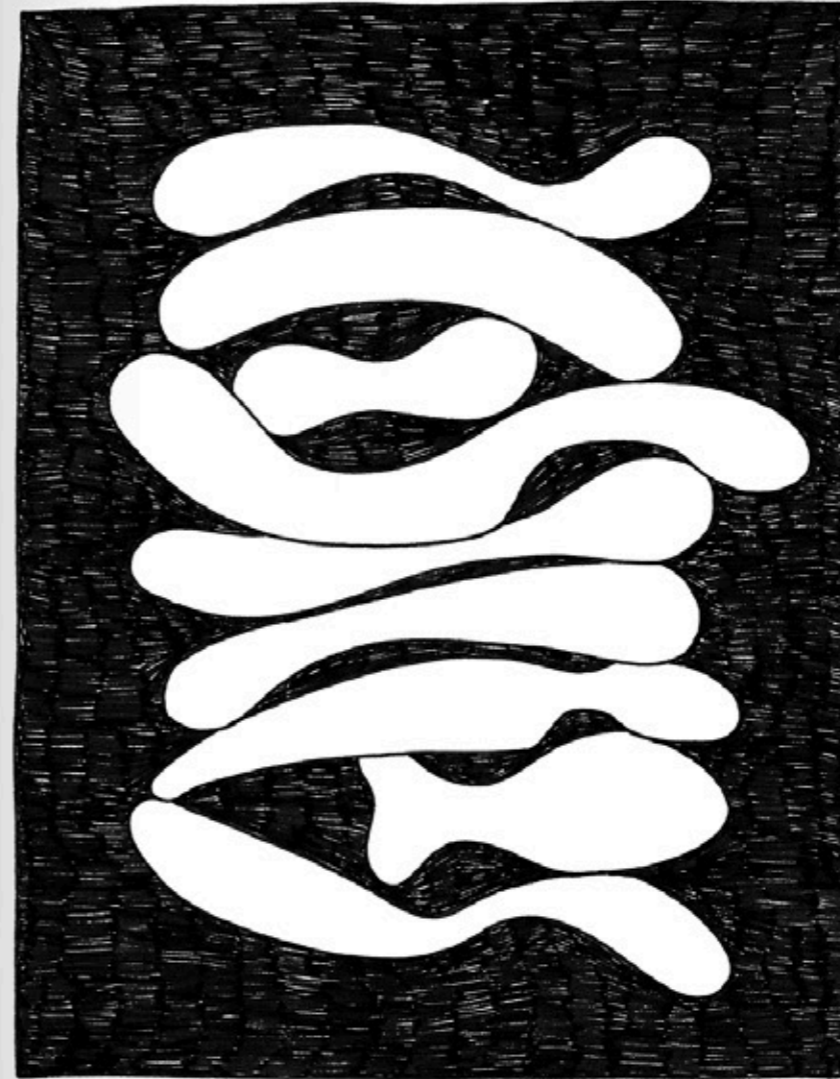

75

AS EASY  
AS  
RIDING  
A BIKE!

96

## PIMP YOUR BIKE

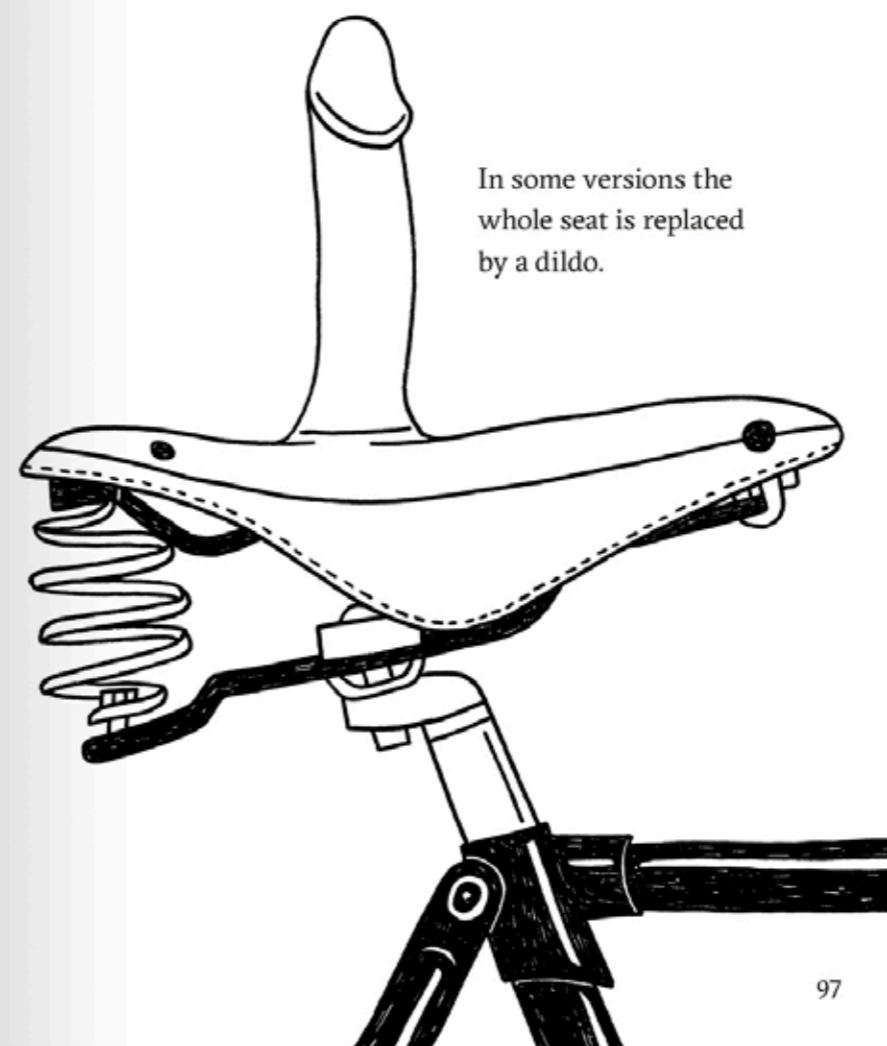

In some versions the  
whole seat is replaced  
by a dildo.

97

# Visually

## An atlas of images in motion

written and illustrated by Pietro Grandi



240 x 320 mm – paperback with flaps

80 p.

20 €

WORLDWIDE RIGHTS AVAILABLE

publication date

February 2022



### Cinema before the cinema was invented.

How many times, while watching an animated movie, did we find ourselves wondering: how on Earth did they make it?

Animating an image isn't just creating a sequence of sketches and than playing it. There's a whole lot of things to know and to do. Through its thorough, vintage tinged pictures, *Visually* by Pietro Grandi leads us to discover the images in motion, their history, all the tools and means man came up with to reveal the dynamics of things: from the horses in the Lascaux caves to the full-length animated films, from shadow plays to the optical disks, from flipbooks to photography.

This book is for reading, but also for doing: just arm yourself with cardboards, pencils, scissors, glue and a box cutter and follow the instructions to recreate the magic of images in motion.

*Pietro Grandi is a digital media designer, founder of the Sensitive Mind studio. He developed multimedia creations, visual music for live shows, immersive video experiences, videomappings and visuals for advertising campaigns, concerts, cultural events, festivals and temporary exhibitions, in collaboration with Italian and worldwide firms. In 2014 he wrote Pixar Story – Passione per il futuro (Hoepli). Since 2019 he's professor of Extramedia techniques and Planning Methodology of Communication at NABA, in Milan.*

# VISUALLY



An ATLAS of  
IMAGES in  
MOTION

written and  
illustrated by  
PIETRO GRANDI



## TABLE of CONTENTS

|                                                |           |                                             |           |
|------------------------------------------------|-----------|---------------------------------------------|-----------|
| SEEING THE WORLD .....                         | 12        | THE MAGIC LANTERN.....                      | 60        |
| THE ILLUSION OF MOTION .....                   | 14        | THE LENS .....                              | 64        |
| SKETCHING THE MOTION.....                      | 18        | THE PHANTASMAGORIA .....                    | 66        |
| SHADOWMANIA.....                               | 20        | THE GRID ILLUSIONS .....                    | 68        |
| <i>How to make a shadow with hands .....</i>   | <i>21</i> | <i>How to create a grid illusion .....</i>  | <i>69</i> |
| THE SILHOUETTE.....                            | 22        | THE DISK ILLUSIONS.....                     | 70        |
| <i>How to make a silhouette .....</i>          | <i>23</i> | <i>How to create a disk illusion .....</i>  | <i>71</i> |
| THE WHITE SHADOW.....                          | 24        | THE THAUMATROPE .....                       | 72        |
| <i>How to make a white shadow .....</i>        | <i>25</i> | <i>How to create a thaumatrope.....</i>     | <i>73</i> |
| THE SHADOW PLAY.....                           | 26        | THE PHENAKISTOSCOPE .....                   | 74        |
| <i>How to create a shadow play .....</i>       | <i>28</i> | <i>How to create a phenakistoscope.....</i> | <i>75</i> |
| THE SHADOW THEATRE.....                        | 30        | THE ZOETROPE.....                           | 78        |
| <i>How to create a shadow theatre.....</i>     | <i>32</i> | <i>How to create a zoetrope.....</i>        | <i>80</i> |
| THE FRAMING.....                               | 34        | THE PRAXINOSCOPE AND                        |           |
| THE FORMATS OF LOOKING.....                    | 36        | THE OPTICAL THEATRE.....                    | 84        |
| THE ANAMORPHOSIS .....                         | 38        | <i>How to create a praxinoscope.....</i>    | <i>86</i> |
| <i>How to see an anamorphosis.....</i>         | <i>40</i> | THE FLIPBOOK .....                          | 90        |
| THE MIRROR .....                               | 42        | <i>How to create a flipbook.....</i>        | <i>92</i> |
| THE KALEIDOSCOPE.....                          | 44        | PHOTOGRAPHY.....                            | 94        |
| <i>How to create a kaleidoscope .....</i>      | <i>45</i> | STEREOSCOPY.....                            | 96        |
| THE DARKROOM .....                             | 46        | CHRONOPHOTOGRAPHY .....                     | 98        |
| <i>How to create a pinhole</i>                 |           | THE CINEMATOGRAPH .....                     | 102       |
| <i>darkroom.....</i>                           | <i>48</i> |                                             |           |
| PANORAMA AND DIORAMA.....                      | 50        |                                             |           |
| <i>How to create a moving panorama .....</i>   | <i>52</i> |                                             |           |
| IL MONDO NOVO AND                              |           |                                             |           |
| THE THEATRICAL DIORAMA.....                    | 54        |                                             |           |
| <i>How to create a mondo novo.....</i>         | <i>56</i> |                                             |           |
| <i>How to create a theatrical diorama.....</i> | <i>58</i> |                                             |           |
|                                                |           | Cinema museum and movie libraries           |           |
|                                                |           | in the world.....                           | 107       |
|                                                |           | Sources and iconographic inspirations.....  | 115       |
|                                                |           | Bibliography and webography.....            | 127       |
|                                                |           | Acknowledgments.....                        | 139       |

## SEEING THE WORLD

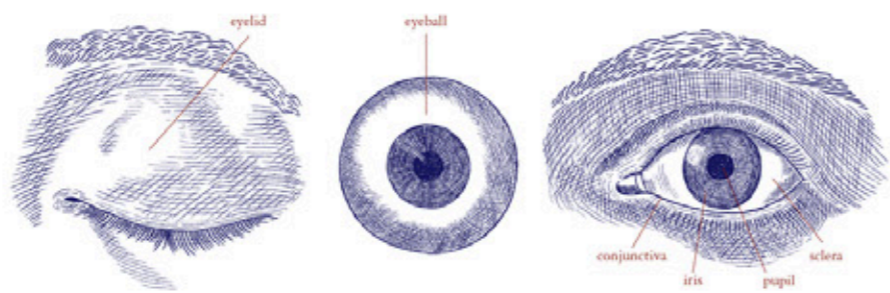

THE ELEMENTS OF A HUMAN EYE

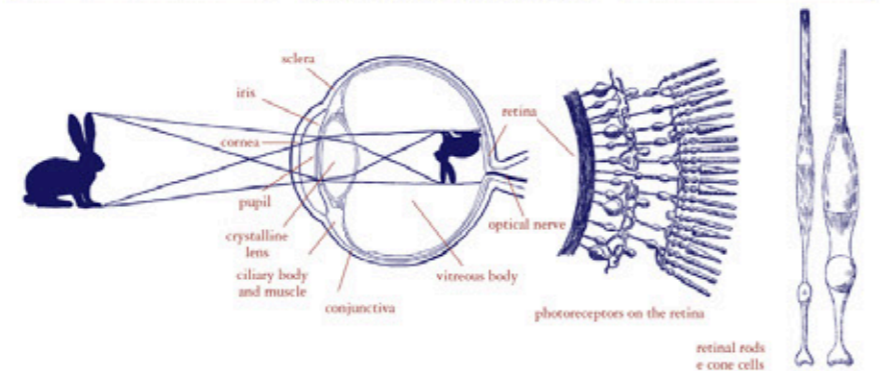

The human eye is often compared to a camera because it features its own sort of lens (the crystalline one) with aperture control (the iris and pupil) which brings the framed object into focus on a light sensitive surface (the retina), which in turn converts the light signals into electrical impulses and transmits them to a calculator (the brain) which eventually creates the image.

But the eye's functioning is different and more sophisticated than a camera's. The eye doesn't just convert objects into images; it sends impulses to the brain, which recreates the image the way we perceive it by

blending the visual senses and processing them based on experience.

We've got two eyes and they see things from two different angles. This is called binocular vision; each eye forms its own image, then the brain elaborates and mixes them in a single one, imbuing it with depth and three-dimensionality and thus allowing us to understand whether an object is near or far and how wide it is. Eyes can see sharply in very different light conditions thanks to the dedicated photoreceptors located on the retina: the retinal rods and the cone cells. Cones

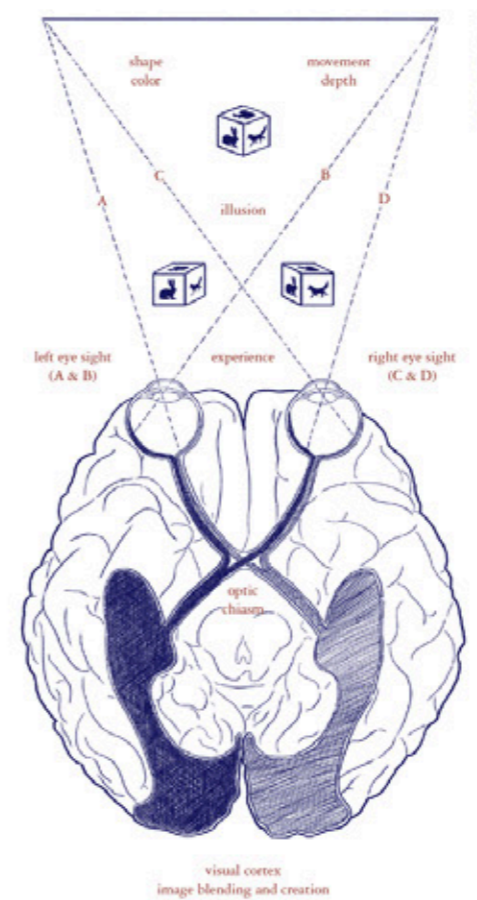

Theories based on *The Age of Insight: The Quest to Understand the Unconscious in Art, Mind, and Brain, from Vienna 1900 to the Present* by Eric Kandel, 2012.

are in charge of diurnal, more fine-grained vision, and are light sensitive; rods deal with night vision, which is less detailed but very sensitive to movement.

So the brain is the one in charge of generating an image by combining visual data passed on by the optical nerve, and does so by elaborating information based on what it already knows, comparing what eyes just saw with what it already saw and recalls. It helps us understanding and acknowledging reality. Ultimately, what we see is a personal hypothesis, formulated by recalling our own past experiences in different light and

distance conditions; when we "see", we're trying to integrate and give meaning to a complex but partial image, guessing its meaning based on what eyes detect. And since we preserve different experiences, everyone's brain comes up with an image which is different from anyone else's.

All in all it's safe to say we see the world around us day after day, and observe surfaces and signs, using our own way of feeling and thinking.

### How to create a shadow theatre

#### Material

- a table lamp with adjustable arm
- a medium-sized packing case
- an A3 cardboard
- a box cutter
- scissors
- a colored tissue paper album
- parchment paper
- transparent duct tape
- a stick glue
- an awl
- a needle
- a roll of black twine
- wood sticks for skewers
- an A4 scanner
- an A3 printer

1. Scan the theatre mock-up, enlarge it and print it on an A3 cardboard. Cut out the proscenium decoration with the scissors.

2. Grab the packing case and build the opening for the proscenium by cutting out the bottom with the cutter. The opening must be as large as the proscenium decoration.



3. Using the duct tape, apply a parchment paper to recreate the screen.

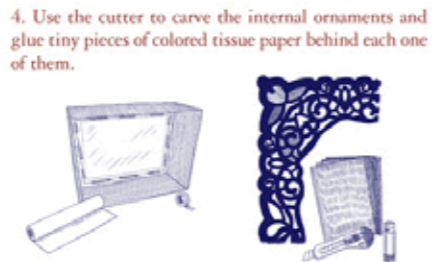

4. Use the cutter to carve the internal ornaments and glue tiny pieces of colored tissue paper behind each one of them.

5. Paste the proscenium decoration on the screen using the stick glue.

6. Use the scissors to cut out the different characters.



7. Pierce each figure's articulation points.

8. Using needle and wire, connect the figure's articulations with knots: you'll make them movable.



9. Strengthen the figures by pasting a couple of wood sticks on their backs: use the duct tape to apply them also on arms and legs, so you'll be able to move the articulations. Some figures will only have a stick in the middle and will therefore be unable to move.

10. Place the lamp table behind you to backlight the screen as well as the decoration, which will project various colors. Use both hands to move different characters, or ask a friend to join you, and you will have your own animated shadows' show.

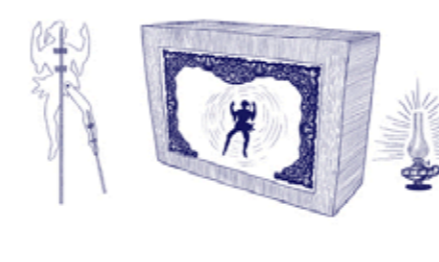

32



Ornamental proscenium and characters for a paper shadow theatre, illustrations based on *Osvaldo dibuixos - Personajes vivos*, figure 6, Polbrán, 1852.

33



# Hyper-Annotated Inventory of All Sorts of Smiles

written and illustrated by Roberta Angeletti



170 x 230 mm – hardback  
94 p.  
18 €

WORLDWIDE RIGHTS AVAILABLE

publication date  
January 2022

**There's a lot of them out there. Everyone has its own. To describe them all, we just needed a... hyper-annotated inventory.**

Smiling is the expression that draws us most closely to those around us, but we don't often manage to spot its secrets and shades at a glance, to recognize its authenticity... and eventually to conceive the world it originated from. Here's a methodical, almost encyclopedic collection of 36 kinds of smile, and – behind them – 36 individuals, ways of being, of relating (or not relating) to others, of talking about oneself, of accepting or turning down the others' gaze. In each one of them, a blending of memories, images, annotations, feelings, affinities, dislikes, connections and reveries match the obser-

vation of the heterogeneous mankind surrounding us. Its entertainment, an accuracy fit for an inventory and its lack of bashfulness will enrich your inner child with charm and amazement by recalling Tim Burton's poetics and Gianni Rodari's grammar of fantasy.

*After a degree in painting, Roberta Angeletti began teaching in middle and high schools. She's always been devoted to illustration, and her works have been published by Italian publishing houses (Emme Edizioni, Castalia, Giunti, Falzea, Mondadori, Edicolors) as well as foreign ones (Belin Editions, Grimm Press, Ragged Bears, Child's Play, Kyowon). She's the inventor and the artistic director of PAGINE A COLORI, a kids' festival of literature and visual arts taking place in Tarquinia since 2005.*





MY MOMMY

*Smile with tears*



Sometimes my mommy has a strange way to smile. While she does it, tears flow from her eyes. I thought it only happened when you squint your eyes for laughing too hard. But with her, it happens when she just smiles and remains silent. You can hear her sniffle even though she hasn't got a cold. It happened the other day too, when she hugged me after I gave her my school report: all As, two A+s and a B in memory. My memory teacher says I'm lazy and I should eat less.

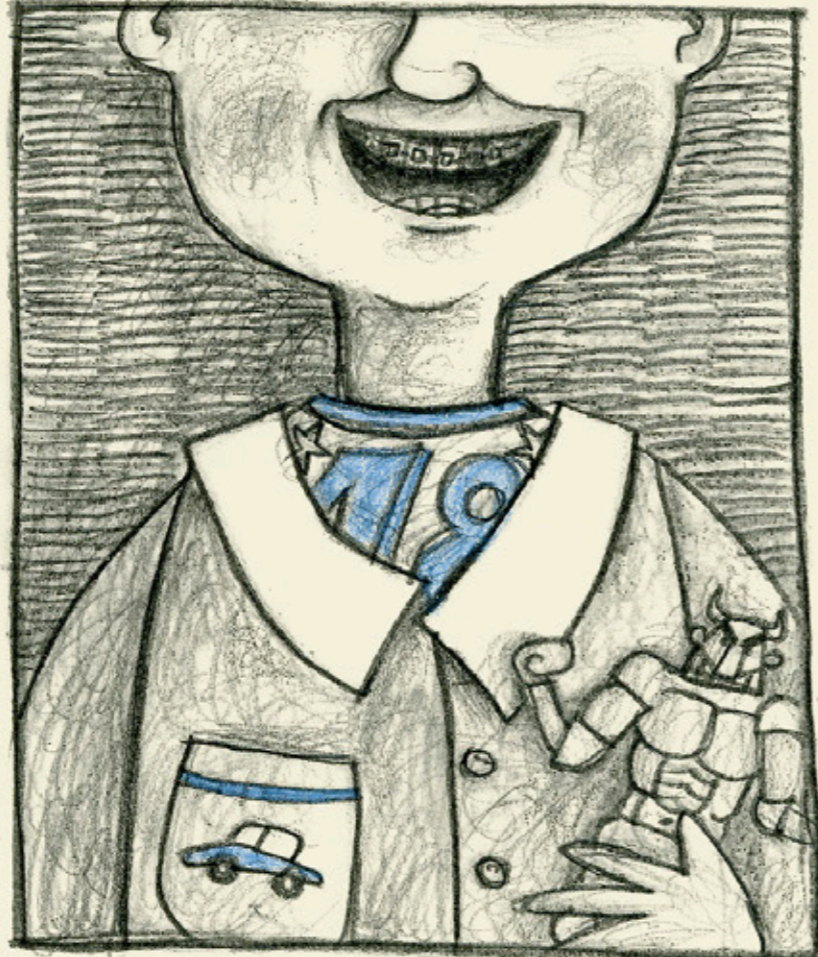

DANIEL FROM IV B

*Smile with braces*



In two years Daniel will enter middle school and he's really worried. He's in IV B but I already know him because we're members of the same basketball team. He told me he's worried because middle school is harder with many stern teachers and lots of homework.

He also admitted one more thing: once he's in the new class, he's scared to be bullied for his braces, the ones he wears on his teeth. As a matter of fact, he's got some sort of caterpillar stuck in his mouth, a bit like mine, that keeps his teeth clenched to straighten them. I told him that with that thing stuffed in his mouth he shouldn't fear anything or anyone, and he should have a laugh about it. I also told him that, should someone try to make a fool of him, he could even try to scare him by showing off his superhero fearsome robotic smile. But Daniel doesn't like to scare people, he's the one who's always scared.



## THE GRANDFATHER

### *Nap smile*



**M**y grandpa usually takes a nap on the armchair after lunch. I guess he does it every day, but I only notice it on Sundays, when we all have lunch at his house. He says he prefers to have the TV on when he dozes, and also allows me and my brother to stay in the room 'cause we won't bother him even when we fight over who's going to choose the TV program. He falls asleep quickly in a brief but sound sleep.

Yesterday I watched him sleep the whole time. He pulled all kinds of faces, snored like crazy, breathed strangely and grumbled like a moka pot. But all of a sudden his face relaxed, in an extremely placid smile that lasted many minutes. I guess during his nap he ran into grandma, who's now gone. I believe they enjoyed a long walk, telling each other how life is going, one here and one there. I'll never forget that grandpa smile. I call it nap smile.

# Elucidata

Donata Columbro – illustrations by Agnese Pagliarini



170 x 240 mm  
220 p.  
18 €

WORLDWIDE RIGHTS AVAILABLE

publication date  
October 2021

**The answer to the world problems is hidden in PDFs nobody will ever read.**

Data are all around us, we produce them while we walk, while we listen to music, while we message friends, while we shop online, while we post on social media. We interpret data when we read a snack's ingredients on its food label while shopping at the supermarket, a place where products get arranged on shelves... based on more data.

Everyday on newspapers we read about facts and figures and, during elections or in times like the ones we're living in, the front pages feature maps and graphs no one ever taught us to read, to fully grasp. Elucidata is a journey within the world of data which will make us look at our ob-

jects and habits in a different, more conscious way, but it will also help us understand a piece featuring charts, Cartesian axes and infographics without feeling lost. And maybe it will help us keep away from fake news.

*Donata Columbro is a journalist and data humanizer: she describes data to make them more... human. For 3 years she managed Dataninja School, the first Italian online education platform for those who want to learn and better communicate data. She's got a regular column on the newspaper «La Stampa» called Data Storie and collaborates with magazines such as «L'Essenziale» and «Uppa Magazine». Since 2022 she's professor of Data Visualization for the Master's Degree in Artificial Intelligence, Business and Society.*

## introduction

PAGE 7

1

WHY DATA IS ALL AROUND US,  
ELUCIDATED

PAGE 13

2

HOW TO READ A NEWS,  
ELUCIDATED

PAGE 27

3

HOW TO READ A GRAPH,  
ELUCIDATED

PAGE 47

4

HOW TO READ A MAP,  
ELUCIDATED

PAGE 73

5

HOW TO PROTECT YOUR DATA,  
ELUCIDATED

PAGE 97

## conclusions

PAGE 117

DATA TO GO FAR (AND TO  
GET FAST ASLEEP)

PAGE 118

## tools

PAGE 121

GLOSSARY

PAGE 122

#SUGGESTEDFORYOU

PAGE 129

BIBLIOGRAPHY | WEBOGRAPHY

PAGE 131

## acknowledgements

PAGE 139

# introduction

# Introduction

In the morning, when you get awakened by the alarm clock, you evaluate your chances to miss the bus if you postpone getting up. When you reach the bus stop you check the time, consider the distance and start running towards the next one: would you have gotten there on time if you walked? A coloured bar on your phone informs you that last night you must have connected the battery charger wrong. Luckily you brought the powerbank with you: you're safe.



**DURING THE FIRST HOUR OF YOUR DAY YOU ALREADY USED ELEMENTS OF STATISTICS AND LOOKED UP A GRAPH TO MAKE DECISIONS ABOUT YOURSELF.**

Data are all around us, you generate them while strolling in the park (think about the pedometer you wear on your wrist or have inside your phone), while listening to music using the Spotify app, to which you're giving information about your musical preferences that it will probably return to you at the end of the year as a nice report full of infographics you'll be able



8

to share on your social media. You generate data when you send messages to your friends, when you shop at the supermarket and swipe your card to get the discounts, when you post something on Facebook. And you stop and interpret data when you read a snack's ingredients and macronutrients on a food label at the supermarket, where products were arranged on shelves in such a way... based on more



data. Even your cutting-edge washing machine gathers data on your washing routine and uses them to suggest you a better time slot for a more eco-friendly laundry and to warn you about refilling the fabric softener in the automatic dosing tank. Some washing machines even use geolocation to know where you are and evaluate if they can end up the laundry in time for you to get home, unload it and hang it!

**What's more, think about the interactions you have with others and with objects you care about.**

How did you choose the house you live in? Maybe you considered its location within the neighbourhood, its proximity to your workplace or to your kids' school, its price, its surface area, its rooms' layout. **More data!**

9

## HANDY LITTLE BOX

### NAME THE ELEMENTS STATED IN THIS MAP

#### INCREASE IN AVERAGE HEIGHT OF WOMEN BORN IN 1996 VS WOMEN BORN IN 1896

HOW DID THE AVERAGE HEIGHT FOR ADULT WOMEN BORN IN 1996, MEASURED IN CENTIMETERS, CHANGE IF COMPARED TO THOSE BORN IN 1896? THIS MAP SHOWS THE DIFFERENCE OF AVERAGE HEIGHT IN WOMEN WHO CAME OF AGE IN 2014 (BORN IN 1996) AND IN THOSE WHO DID SO IN 1914. THE MAJOR CHANGE HAPPENED IN WOMEN FROM SOUTH KOREA, WHERE THE AVERAGE HEIGHT GREW BY 20 CENTIMETERS, WHILE THE MINOR ONE TOOK PLACE IN MADAGASCAR, WITH AN INCREASE OF JUST 1.5 CENTIMETERS.

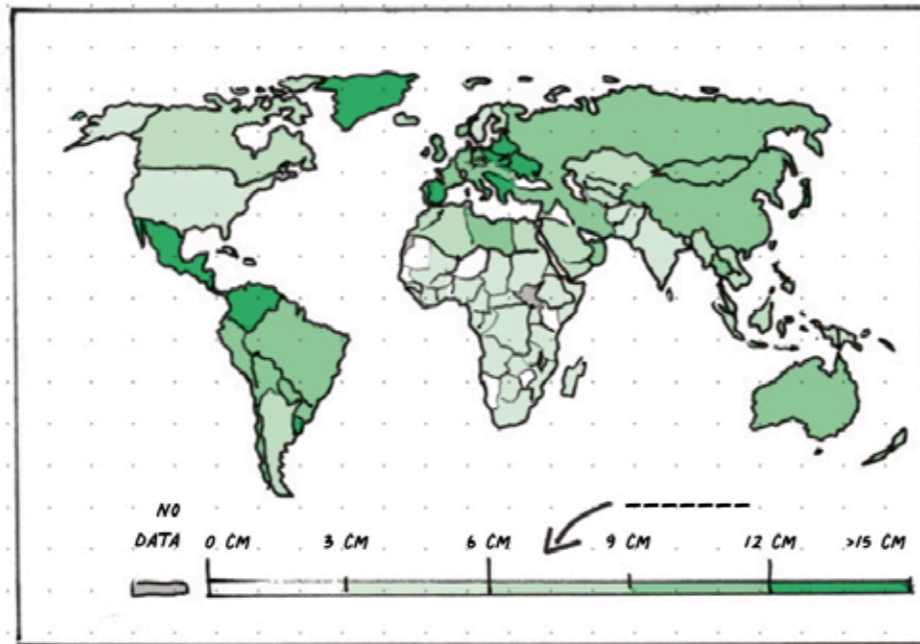

MAP: OUR WORLD IN DATA

SOURCE: NCD RISC, HUMAN HEIGHT (2017)

94

## HANDY LITTLE BOX

### CHECK THE RIGHT ANSWER

- 1) THIS IS A:  
 CHOROPLETH MAP  
 PROPORTIONAL SYMBOL MAP  
 POSITION MAP
- 2) THE DARKER COLORS INDICATE:  
 WHERE A MINOR CHANGE TOOK PLACE  
 WHERE MOST TALL WOMEN LIVE  
 WHERE A MAJOR CHANGE TOOK PLACE
- 3) IN INDIA THERE WAS NO HEIGHT INCREASE OF MORE THAN 6 CM:  
 TRUE  
 FALSE
- 4) THE LATEST ANSWER IS \_\_\_ BECAUSE IT'S A \_\_\_ VALUE.
- 5) THE PROJECTION USED TO DRAW THIS MAP IS:  
 MERCATOR  
 GALL-PETERS  
 ANOTHER TYPE OF PROJECTION

#### ANSWERS

1. CHOROPLETH 2. WHERE A MAJOR CHANGE TOOK PLACE  
3. FALSE 4. FALSE 5. MERCATOR

95



# Vinyl

## A comprehensive guide

Antonio Saluzzi



140 x 210 mm – paperback

192 p.

13 €

WORLDWIDE RIGHTS AVAILABLE

publication date

October 2018

**Trail-off, Mint, Atg, Dead Wax, Obi... who would have thought that a 11 inches vinyl record could hide so many secrets? Vinyl, a comprehensive guide is the map you needed to sail around the world of 33 rpm (or 45 rpm) music records.**

Vinyl is dead, long live the vinyl! The third millennium saw the groundbreaking comeback of 33 rpm records. And that happened despite, or maybe thanks to the diffusion of volatile music with no storage medium such as MP3 files. The blogger Antonio Saluzzi, with a meticulous yet captivating and easy-going style, becomes an invaluable adviser to discover the history of LPs, to find out which of the 465 White Album versions we own, to choose the best method to “wash” our collector’s items, to look up specialized magazines and

websites, to buy the record player and audio system matching the desires and needs of each one of us. This handbook will become a security blanket for audiophiles and neophytes: we’ll spot it by the arms of all fairs, shops and street markets regulars.

*Antonio Saluzzi, author of “Alla ricerca del vinile perfetto” – one the most read and quoted Italian blogs dedicated to the world of vinyls – has been pursuing the passion for analog music and vinylic supports for years. He uses to innocently wander around local markets, fairs and record shops, and doesn’t turn his nose up at some dangerous descent in abandoned basements to get his hands on some musical gems of the past to be enjoyed strictly on an authentic 1980s hi-fi audio system.*

## 1 A BIT OF HISTORY

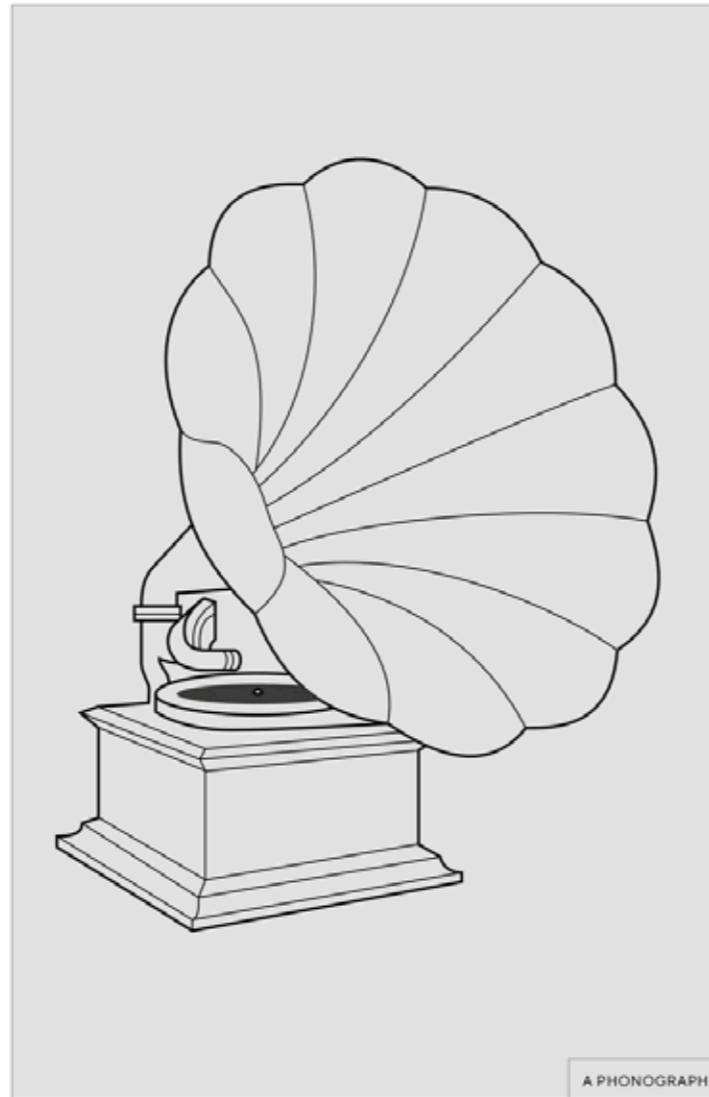

12

## 1.1 From the phonograph to LPs

The history of records starts with the chance for man to record sounds. In 1877 the American inventor and entrepreneur Thomas Edison tested himself with the telegraph, a device he had invented to allow communication at a distance. Edison had already found a way to record morse sounds by engraving spiral traces on a metal medium. This way, he could respond to certain messages without the operator's intervention. But on July 17th of that year he had a brainwave which was to change history: if the cylinder turned fast enough, the stylus would radiate vibrations which recalled the human voice.

Edison went on working on his insight for months, and on November 21st he announced the phonograph was born. Some days later, on the 6th of December, he shared the device's first exhibition with his collaborators.

The audience was met by a machinery made up of an iron cylinder covered by tin foil, a stylus connected to a vibrating membrane and a crank.

When the crank got turned and sounds were produced close to the membrane, this one would vibrate causing the stylus to move and inscribe grooves on the tin foil cylinder. By bringing the stylus back to the starting point, the device was able to reproduce the recorded sounds.

Facing an actually skeptical audience, Edison turned the machinery on and spelled the first verse of a well-known English nursery rhyme:

*Mary had a little lamb,  
Whose fleece was white as snow.  
And everywhere that Mary went,  
The lamb was sure to go.*

13

### 3 A VINYL'S ANATOMY

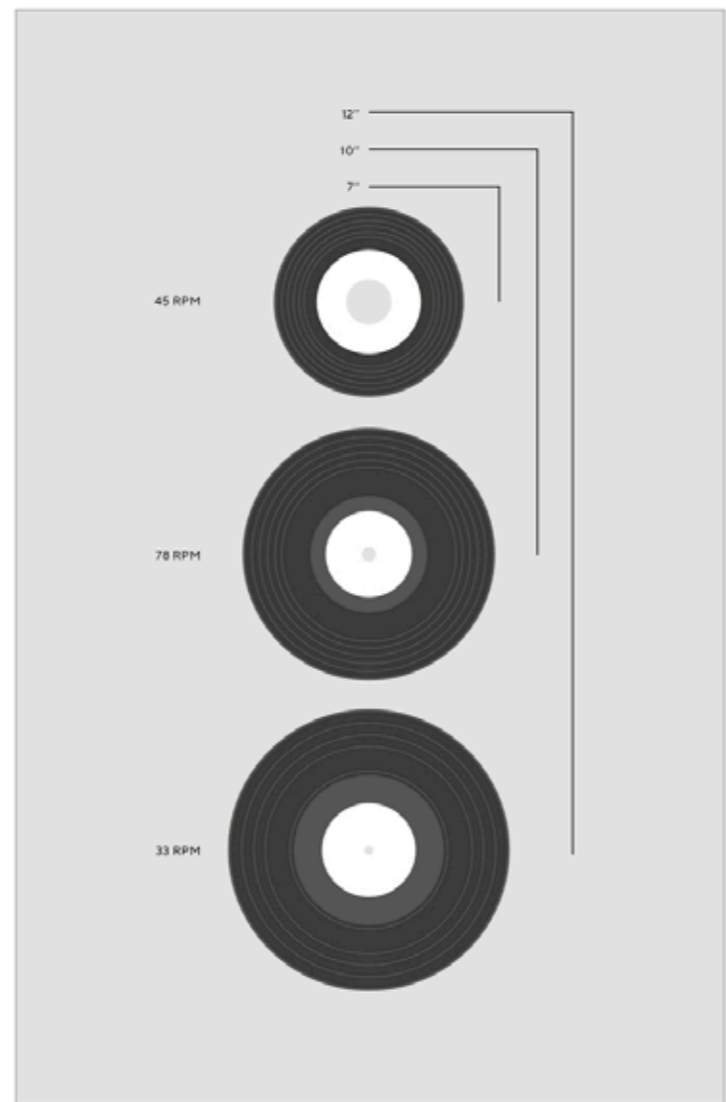

### 3.1 The various formats

**LP – 33 RPM.** It's the king of vinyls and it doesn't need any introduction. It's 12 inches wide, turns at 33 rounds and a third per minute and is used for albums, or records containing a number of songs.

Since the grooves' width affects the quality of the recording, to be acoustically satisfactory an LP should include 24 minutes of music on each side at the longest. An album of superb quality recording (around +6 dB) can include as many as 8 minutes of music on each side, one of an average quality (around +4 dB) as many as 11 minutes.

Wider-scope pieces are often released on double LPs. More uncommon, at least in the past, were the triple LPs (famous are George Harrison's *All Things Must Pass*, Yes' *Yessongs* and Smashing Pumpkins' *Mellon Collie And The Infinite Sadness*). Collections of four or more LPs are called box sets, slipcases which may gather together records formerly issued separately and often including additional material.

**Single – 45 RPM.** The other standard for vinyl music is 7 inches wide and turns at 45 rounds per minute. It's especially suitable to contain one song on a side and a B-side on the other one, lasting around 4 minutes per side. Since its release, it became one of the most used and loved formats as well as the collectors' most coveted medium. Most of the records reaching top prices spin at 45 rounds.

**EP.** Short for Extended Play. It's a 45 RPM with more than one song (usually two) on each side. A very common format between the 1950s and the 1960s, it then got replaced by the LP. Also EPs can reach very high quotations.

## 11 THE RECORD PLAYER

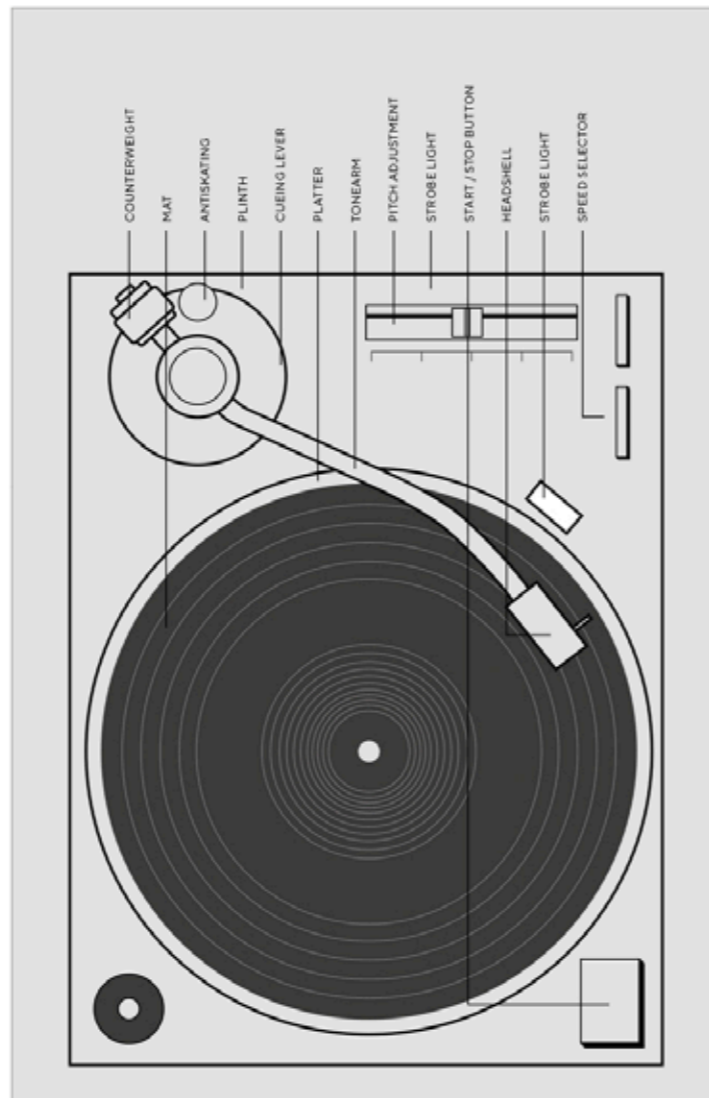

148

Talking about record players and what was once rightly called “hi-fi chain” is a way to realize how fast the world has changed (and not always for the best).

The parents of those born between the 1970s and the 1980s, grown up with a hands-on vision of reality (namely a generation of people who knew how to restart a broken car using a pair of stockings) and capable of handling decently high fidelity, record players, amplifiers and speakers, is now living side by side with millennials, individuals who grew up in a world where everything is just a click away and who never even heard of preamplifiers and loudspeakers.

### 11.1 How a record player is made

The inner workings of a record player are basically the same since the gramophone era (1892).

An engine starts the platter, on which gets laid the record which then spins at a regular pace.

Secured beside the platter there’s a tonearm with a tiny diamond stylus at the far end, which gets tossed within the record grooves. The tossings aren’t random at all: on the contrary, they depend on extremely precise information which the stylus sends to a magnet and a reel arranged inside a little box called needle, located a few millimeters away.

The magnet and the reel transform the stylus movements into electric signals; these eventually go through a system which amplifies them a thousand times and sends them to one or more amplifiers set on the system sides.

149

# Chocolate

## Theobromine 650mg

Arianna Rossoni



170 x 240 cm – paperback + box  
128 p.  
10 €

WORLDWIDE RIGHTS AVAILABLE

publication date  
November 2018



**Science proves it: chocolate gives happiness! Ask the theobromine, the active ingredient that makes it so special.**

Chocolate can be man's best friend or his worst enemy. The difference, like for a very ordinary aspirin, lies in doses, interactions, composition and conservation methods. Dietician Arianna Rossoni, renowned and highly followed on social media both as @una-dietistacontrocorrente (on Instagram) and as Alimentazione in equilibrio (on Facebook and as a blog author), draws up a "product information insert" for chocolate, thanks to which we're going to find out the reason why women raid the pantry once a month on the hunt for a chocolate square, why a tablet stored at an excessively low tempera-

ture will develop that inauspicious and uninviting white glaze, or what's the anti-inflammatory power of high quality extra-dark chocolate. *Chocolate. Theobromine 650mg* teaches us to keep away from cliches (chocolate itself is NOT responsible for fattening) while leading us towards a more prudent and responsible usage of one of everyone's most tasty foods.

*Arianna Rossoni, a dietician specializing in nutrition and fecundity, hypothyroidism and autoimmune diseases, created the now highly followed website and blog Alimentazione in equilibrio. She's a professor at Scuola Nutrizione Salernitana since 2014. She usually holds various courses both in Padova, where she lives and works, and around Italy.*



## Table of contents

|     |                                                       |
|-----|-------------------------------------------------------|
| 4   | <b>What you need to know before reading</b>           |
| 11  | <b>Active ingredients and therapeutic indications</b> |
| 21  | <i>Extra: History of cocoa and its plantation</i>     |
| 26  | <i>Extra: Chocolate, mon amour</i>                    |
| 33  | <b>Ingredients</b>                                    |
| 42  | <i>Extra: Plantation, production and quality</i>      |
| 47  | <b>Conservation and expiry date</b>                   |
| 51  | <i>Extra: Recipes</i>                                 |
| 61  | <b>Warnings and interactions</b>                      |
| 66  | <i>Extra: Chocolate: true or false?</i>               |
| 73  | <b>Shortcomings and toxicity</b>                      |
| 81  | <i>Extra: Pets and chocolate poisoning</i>            |
| 83  | <b>Administration and conditions of use</b>           |
| 96  | <i>Extra: Classic and unusual pairings</i>            |
| 101 | <b>Types on the market</b>                            |
| 112 | <i>Extra: Organoleptic analysis and tasting</i>       |
| 121 | <b>Bibliography</b>                                   |

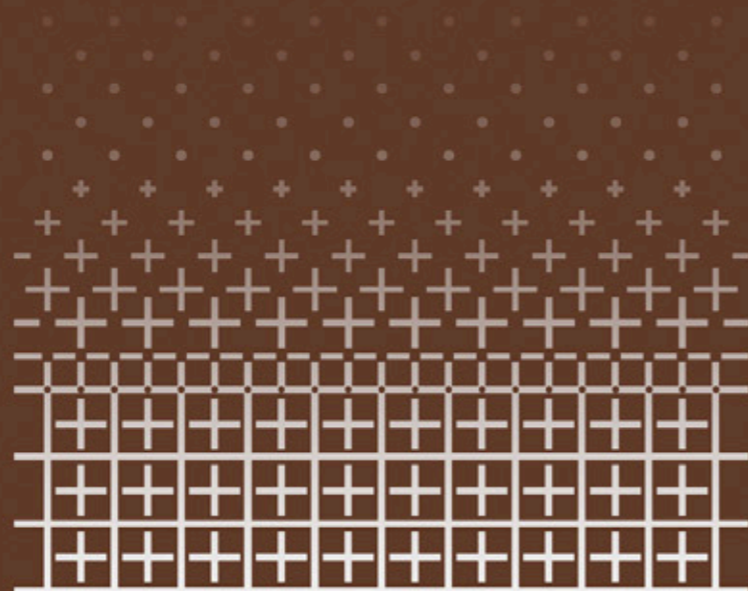

### How to read spread creams' food labels



**Ingredients:**  
sugar, vegetable oil,  
hazelnuts (13%), skimmed  
cocoa (7.4%), skimmed  
milk powder (6.6%),  
powder milk whey, soy  
lecithin, vanilla.



**Ingredients:**  
brown sugar, hazelnut  
paste 18%, sunflower  
oil, skimmed milk  
powder, cocoa (6.5%),  
cocoa butter, sunflower  
lecithin, vanilla stock.



**Ingredients:**  
"tonda gentile  
Trilobata" type  
hazelnuts, sugar, cocoa  
mass, skimmed cocoa  
powder 10-12%, cocoa  
butter, emulsifier:  
sunflower lecithin.  
(minimum 22% of cocoa).

Types on the market

1. The first ingredient is the one included at the highest concentration: it shouldn't be sugar.
2. Sugar should better be brown.
3. The % of hazelnuts should be the highest possible, around 40-50%. Even better if the hazelnuts are refined, like the tonda gentile from Piedmont.
4. The best fats to be used are cocoa butter above all, followed by sunflower oil. Distrust ambiguous "vegetable oil" indications, as they almost always disguise the usage of palm or rapeseed oil.
5. The soy and sunflower lecithins are used as emulsifiers and are thus irrelevant for nutritional purposes.
6. The skimmed milk powder is used to give the spreadable effect; if it's milk powder-free, the cream is going to be more refined. If anything, creams with whole milk powder are better than those with skimmed milk one.
7. About the cocoa: creams including both cocoa powder and cocoa mass are of higher quality.

# Sake

## A shot of Japan

Marco Massarotto



170 x 240 mm  
hardcover with dust jacket  
192 p.  
22 €

WORLDWIDE RIGHTS AVAILABLE

publication date  
September 2018

### Sake Road

Sake has always been the counterpart of wine in Japan, but nowadays it's taking advantage of an ever-growing diffusion. It has become a cool and innovative drink in many international big cities (London, New York, Singapore), where it's being served within the best Japanese restaurants, mixed by bartenders of the most renowned clubs and hotels, and used by famous chefs as an extension of their beverage range. *Sake. A shot of Japan* is an educational handbook in a paperback format featuring archive and authentic photographs. But at the same time it's a tablebook with a unique graphic project: dedicated illustrations, internal pages made out of eco-friendly paper obtained by algae and a cover

created using rice paper. The essay analyses such a historically and qualitatively unique product from every viewpoint: its origins and production, its types and serving secrets, its pairings and uses in cooking. A thorough book which will keep its worth through the years, surging as a reference point for whoever should want to approach the Japanese drink.

*Marco Massarotto is the founder of the non-profit cultural association called La Via Del Sake and promotes the Milan Sake Festival. He graduated as sake expert, sake sommelier and Kikisake-shi (sake master) at Tokyo's SSI and at London's WSET, first among Italians, and at London's SSA. In 2015 he was appointed as Kyoto Tourist Ambassador by the Tokyo major Daisahu Kadokawa. He's a counselor and advisor on sake for importers, distributors and famed chefs.*



---

**INTRODUCTION** ..... 9

---

**1. DEFINITION AND TERMS** ..... 11

- The ideogram for sake ..... 13
- Nihonshu*: the Japanese wine ..... 14
- The technical definition for sake ..... 15
- Historical boundaries to the diffusion of sake ..... 18

---

**2. HISTORY AND CULTURE OF SAKE** 25

- Origins ..... 27
- The drink of gods ..... 27
- Geisha and samurai ..... 28
- Ancient times ..... 30
- Middle Ages ..... 32
- Modern times ..... 35
- Sake today ..... 37
- The future of sake ..... 38

---

**3. THE PRODUCTION'S PLACES AND KEY PLAYERS** ..... 41

- The *kura* or cellar ..... 43
- The home micro-cellar ..... 43
- The small cellar ..... 44
- The midsized cellar ..... 45
- The wide cellar ..... 45
- The production's key players ..... 46
- Kuramoto* ..... 47
- Toji* ..... 52
- Kurabito* ..... 57
- Le *Sakauta* ..... 58

---

**4. INGREDIENTS** ..... 61

- The purest drink ..... 63
- Water ..... 63
- Rice ..... 65
- Kōji* ..... 68
- Yeast ..... 69
- Added alcohol ..... 71

---

**5. THE PRODUCTION** ..... 73

- Historical mentions about the production techniques ..... 75
- Kan-zukuri*: the winter production ..... 75
- The production stages ..... 76
- The purchase and selection of rice ..... 76
- The refining ..... 78
- The washing and soaking ..... 79
- The cooking and cooling ..... 80
- The saccharification ..... 80
- The fermentation base ..... 82
- The fermentation ..... 85
- The pressing ..... 87
- The finishing ..... 89
- The first pasteurization ..... 90
- The sharpening and dilution ..... 90
- The second pasteurization ..... 91
- The bottling ..... 92

---

**6. SAKE TYPES AND CLASSIFICATION** ..... 97

- Seishu*: the sake according to the law ..... 99
- Genshu*: the undiluted sake ..... 99
- Putsū-shu*: the table sake ..... 99

- Special denominations ..... 100
- Junmai* ..... 102
- Ginjō* and *daiginjō* ..... 102
- Other denominations ..... 103

---

**7. PRODUCTION AREAS** ..... 111

- A "virtual terroir" ..... 113
- The geography of Japan ..... 114
- Northeastern Japanese sake ..... 116
- Central Japanese sake ..... 118
- Western Japanese sake ..... 121
- The sake production outside Japan ..... 122

---

**8. STORAGE AND SERVICE** ..... 125

- The perfect conditions of storage ..... 127
- How to spot a flawed sake ..... 127
- The service containers ..... 128
- Masu* ..... 128
- Ochoko* ..... 129
- Tokkuri* and *Katakuchi* ..... 132
- Taru* ..... 133
- The ISO tasting glasses ..... 135
- Hot or cold? ..... 136
- The service ..... 136
- Izakaya* ..... 138

---

**9. TASTING AND PAIRINGS** ..... 141

- The technical tasting ..... 143
- Five rules for pairing ..... 145
- Clams in sake ..... 150
- Ribs marinated in sake ..... 152

- Mushrooms in sake with coriander salad and glazed tofu ..... 154

---

**10. COCKTAILS** ..... 157

- The cocktails ..... 159
- Sakari* ..... 161
- Mitsuoko* ..... 162
- Shinsen* ..... 163
- Sake's kins:
  - Shōchū* and *umeshu* ..... 164
  - Japanese ice ..... 165

---

**11. THE SAKE AMBASSADORS: GEISHA, SOMMELIERS OR SAMURAI?** ..... 169

- Schools and courses ..... 171
- Awards and contests ..... 173
- Festivals ..... 174
- Sake Samurai and Miss Sake ..... 175
- Collaboration projects ..... 175

---

**12. WEBOGRAPHY AND BIBLIOGRAPHY** ..... 176

- Webography ..... 181
- Bibliography ..... 187

---

**ACKNOWLEDGEMENTS** ..... 189

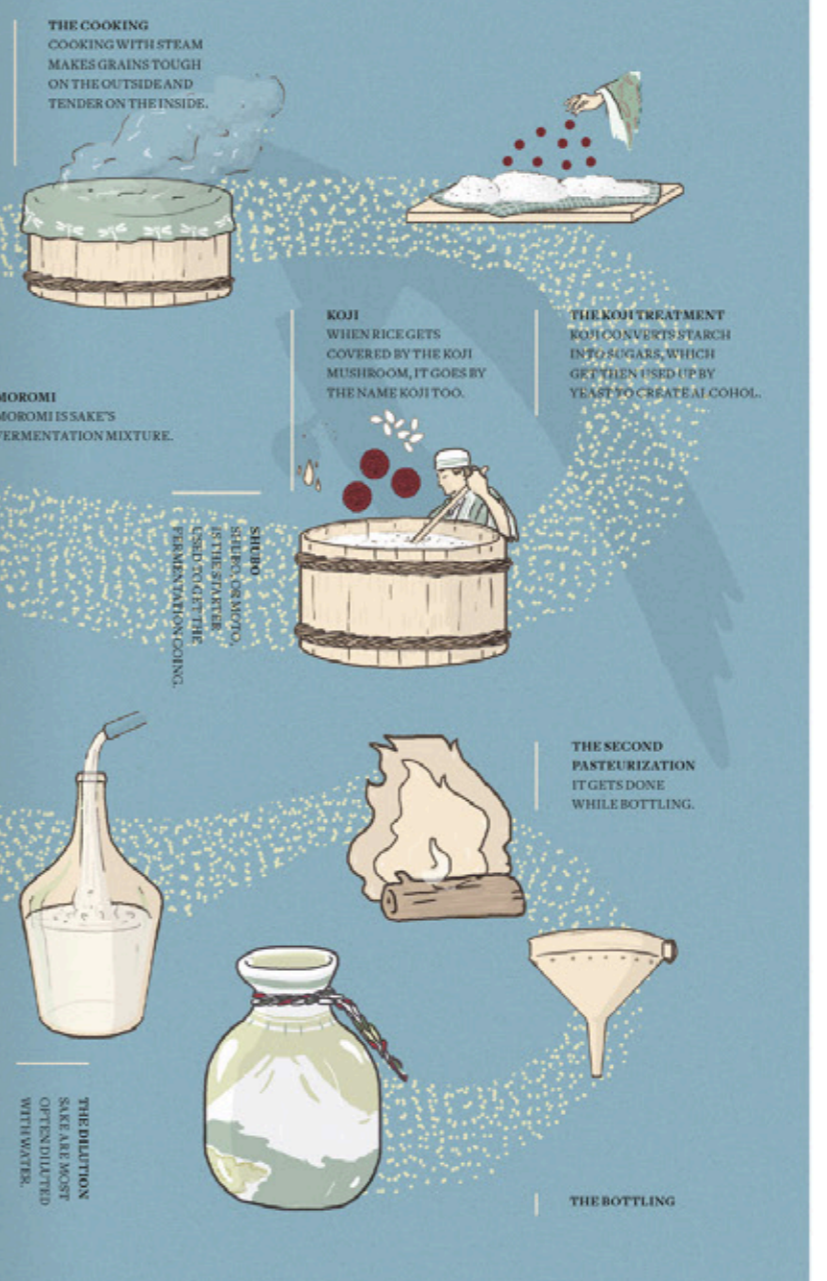
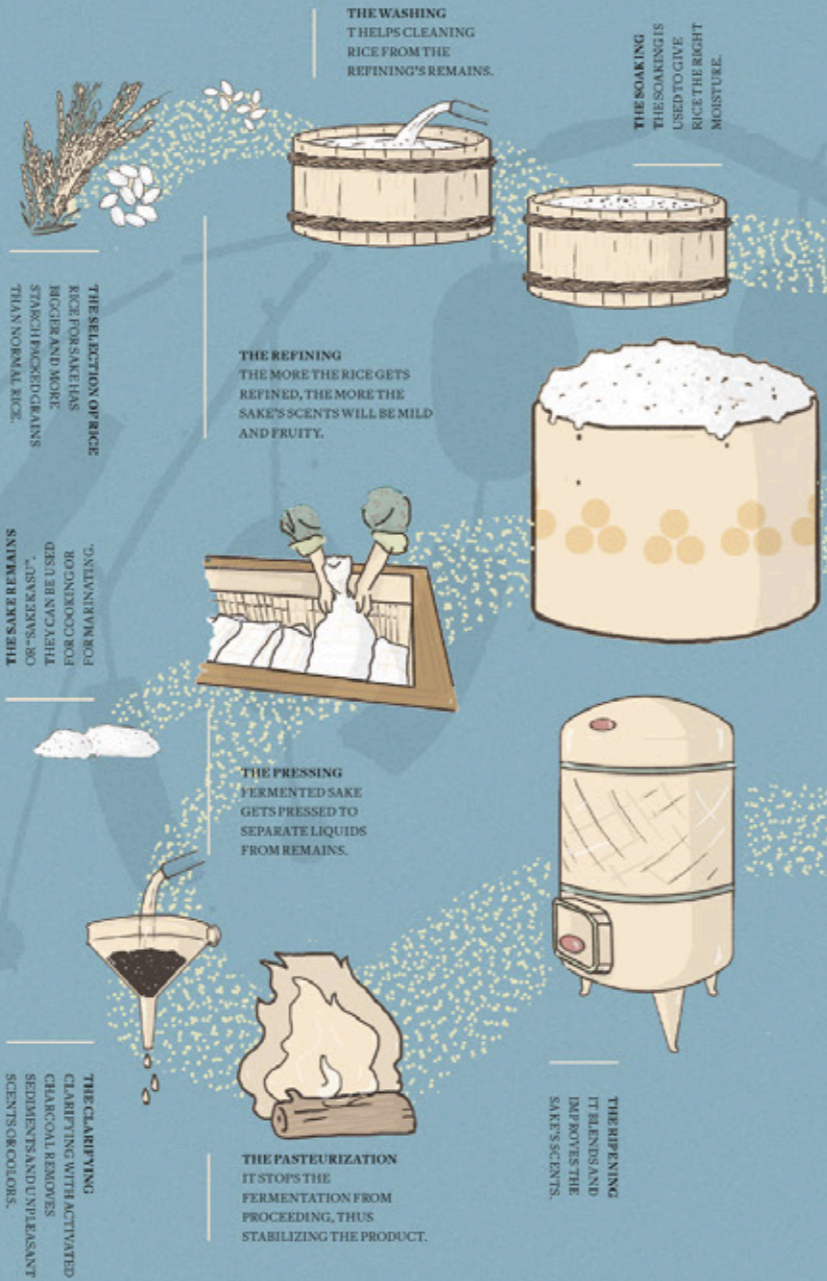



## MITSUOKO

CREATED BY ALESSIO SIMONINI

### INGREDIENTS

- Sake Tokubetsu Junmai
- Lemon beerbrush liqueur
- Dry vermouth instilled under vacuum with sansho pepper and lemongrass
- Kodakara yuzushu
- Black tea bitter aperitif
- Scent of cedarwood



sake  
|  
162

Stir & Strain, mix all the alcoholic ingredients on ice except for the scent of cedarwood. Filter them in a pottery cup on a fresh ice block. Before serving, spice up with the cedarwood fragrance.

ALESSIO SIMONINI, 28 years old, is a certified sake sommelier and Sakeya manager and loves high quality mixology. He's been working in various Milan and worldwide clubs, like in Australia and Barbados. He likes to surprise people with original forms, scents and tastes.



## SHINSEN

CREATED BY NICOLA MANGIACAPRA

### INGREDIENTS

- 45 ml Junmai Ginjo
- 5 ml Cherry Heering
- 10 ml Carpano Antica Formula
- 20 ml Sorrento lemon juice
- 15 ml Yuzu syrup (1.5:1)



sake  
|  
163

Shake & Double Strain. Shake all the ingredients with pure ice and filter them in a coupe previously decorated with cinnamon powder.

NICOLA MANGIACAPRA, 26 years old, is a certified sake sommelier and founder of Diamond in a Glass, a seminar on Japanese culture and mixology. He's the bartender for L'Antiquario in Naples.

---

# Recovery Times

## Scraps, leftovers and tradition in the famous chefs' kitchens

---

Carlo Catani

---



---

170 x 240 mm – paperback

228 p.

23 €

---

WORLDWIDE RIGHTS AVAILABLE

---

publication date

August 2018

---

### The culinary art of recycling

A new “recycling culture” is building up concerning the best cooking practices around the world. This renewed awareness also engaged key players of international cuisine like Massimo Bottura, ideator of the Food for Soul project, with solid initiatives worldwide where cooking with leftovers perfectly pairs with social calling. *Recovery Times* brought to the burners more than forty among cooks, *azdore* (women from Emilia-Romagna who traditionally prepare fresh pasta from puff pastry) and famed chefs, who give their own rendition of the recycling theme through their dishes, underlining its economic and social significance and proposing new solutions to fight food waste. Carlo Catani collected voices, fa-

ces, images, statements, recipes and in-depth studies on history, techniques and raw materials, turning it all into an unmissable book introduced by Carlo Petrini – Slow Food ideator and chairperson – and printed on a one-of-a-kind paper, which originates from scraps of raw materials saved from the dump – like citrus and kiwi fruits, grapes, cherries, lavender, corn, olives, coffee, hazelnuts and almonds – and therefore benefits from an unusual tactile peculiarity.

*After nine years working for a bank, Carlo Catani decided to turn his enogastronomic passion into a job. He took charge of a restaurant and participated in setting up the University of Food Science in Pollenzo, which he directed for five years. He's now the promoter for the Cinemadivino exposition, collaborating with the Chef to Chef association and counseling for various companies besides setting up food and wine events.*

*preface*  
by Carlo Petrini

— — — — —

RECOVERY TIMES - preface | 12

Since the dawn of time, good practices regarding the recovery of leftovers and less priced ingredients belong to the cooking and artisanal heritage of every group of people around the world. There's nothing new under the sun: the needs to store food and to get the best of it have always been the pillars of home cooking, the main method of human creativity.

We need to remember – it may sound evident, but maybe not – that food abundance in our fridges and larders is quite a new fact, while for a long time the vast majority of the world population couldn't even imagine such thing. An abundance which, while eventually put an end to the anxiety of eking out a living, broke up that bond of sacredness and reverence that always tied human communities to their food and the environment which granted its supplying. That's why nowadays, during a time in which cooking and culinary arts are being talked about like never before, it's essential to work hard and reconnect man with his food. Even though pressure isn't as much about quantity as before, new rising considerations

make us wonder and encourage us to modify our consumerism model, even our approach to food and its fruition. Producing food isn't indeed an unresponsive process, since it requires work, energy (always more frequently too much fossil energy), water resources and the precondition to use fertile soils. All of this has an impact on the environment we live in and, as a consequence, on the very same chance of our sons and grandsons to produce food itself in the future.

We can't afford to underestimate this matter, first of all to be ethically consistent with 800 millions of still malnourished people who should upset everyone of us, but also, more prosaically, because there's an increasingly actual risk that food production might become the first cause of destruction of our planet (as of now, the food system is already responsible for about 25% of all greenhouse gas emissions). Therefore, every initiative focusing on raising awareness of reduction of food waste and the spread of recovery methods and techniques should be greeted enthusiastically.

*Recovery Times* carries out the task in a particularly pleasant way, combining recipes with in-depth analyses and developing such an urgent theme with a joyous and motivating approach. An useful and really good work, which tastefully describes the great strength of a simple and absolutely relevant idea. Enjoy the book!

**Carlo Petrini**

*Founder of the international "Slow Food" Movement*

RECOVERY TIMES - preface | 13



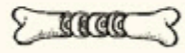

## Little fried bovine meatballs from Emilia Romagna with tomato sauce

by Simone Zoli



### Ingredients

- 1.10 pounds bovine stewing steak from Emilia Romagna
- 3.5 ounces minced Coppa di Parma or loin pork cuts
- 5 ounces boiled beef mince
- 1 garlic clove
- 1 shallot
- a clump of parsley
- 3.5 ounces parmigiano reggiano
- 3.5 ounces ricotta cheese
- 1 egg
- extra virgin olive oil
- salt, pepper

### to bread them

- 4 eggs
- 00 grade wheat flour
- breadcrumbs

### to cook them

- oil for frying

Cook the peeled garlic in a small amount of oil on very low heat until it sweats, then chop it up thin. Throw it in a bowl and add all the minced meats, seasoning with the grated parmigiano, the well wringed ricotta, an egg, the minced parsley and shallot, salt and pepper.

Use your hands to form little meatballs, around 2cm in diameter, which you will then roll over in flour, in beaten eggs and eventually in breadcrumbs.

In a frying pan, or even better in a fryer, heat the oil over 356 °F and cook the meatballs for about 4 minutes, draining them as soon as they turn a nice hazel.

The little meatballs can be served right out of the pan or with a light tomato sauce, topping it with some chive stems and some drops of balsamic vinegar.



RECOVERY TIMES - second stage

62

RECOVERY TIMES - second stage

63

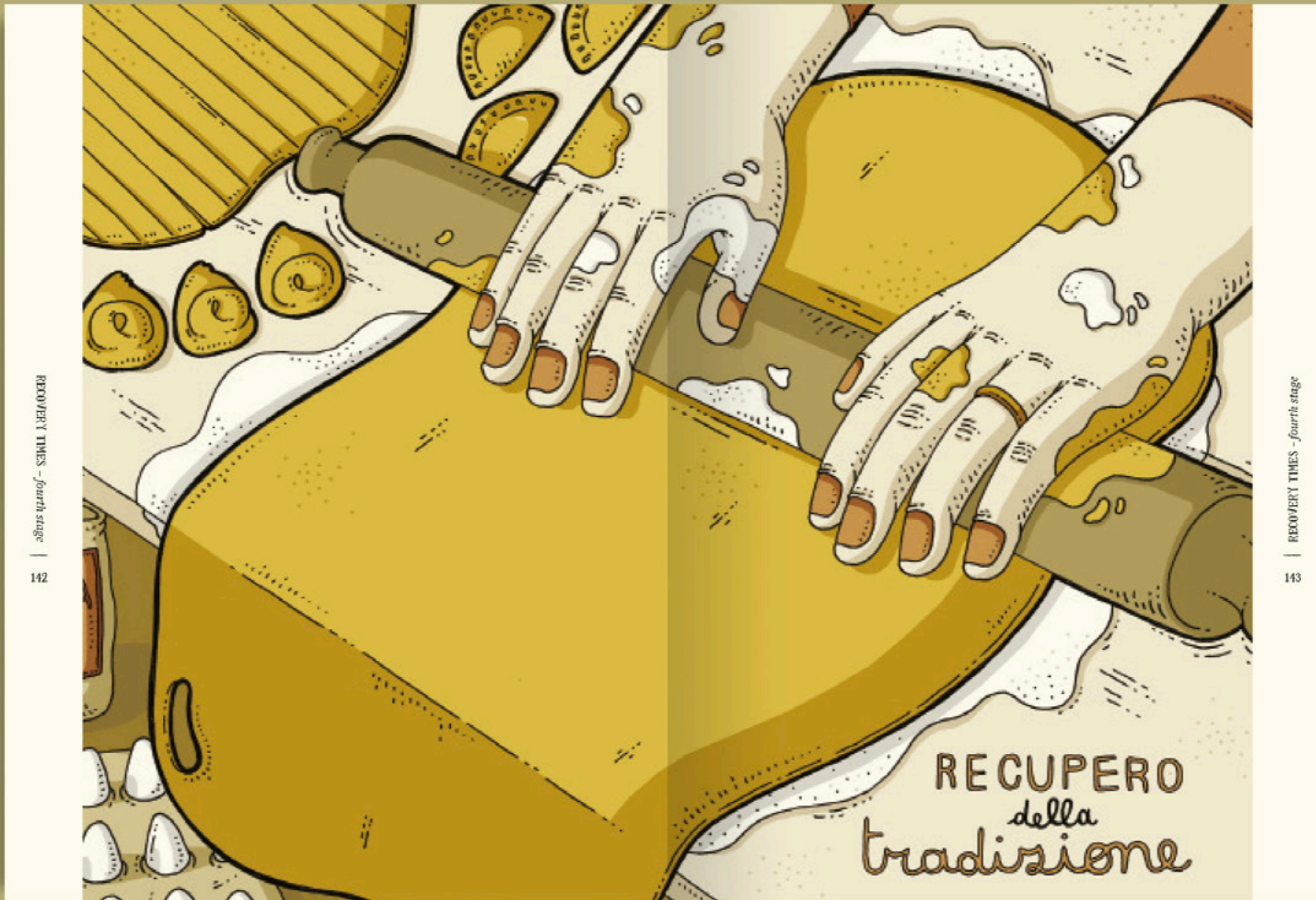

RECOVERY TIMES - fourth stage | 142

RECOVERY TIMES - fourth stage | 143



**QUINTO QUARTO Edizioni srl**

Corso Matteotti, 2 - 48018 Faenza

[quintoquartoedizioni.it](http://quintoquartoedizioni.it)

---

**Publisher**

**Marco Ghezzi**

[marcog@quiqua.it](mailto:marcog@quiqua.it)

**Maura Romeo**

[maura@quiqua.it](mailto:maura@quiqua.it)

**Editor**

**Maura Romeo**

[maura@quiqua.it](mailto:maura@quiqua.it)

**Rachele Palmieri**

[rachele@quiqua.it](mailto:rachele@quiqua.it)

**Art director**

**Agnese Pagliarini**

[agnese@quiqua.it](mailto:agnese@quiqua.it)

**Foreign rights**

**Valentina Colombo | Phileas Fogg Agency**

[valentina@phileasfoggagency.com](mailto:valentina@phileasfoggagency.com)

**Press officer**

**Roberta De Marchis**

[demarchisroberta@quiqua.it](mailto:demarchisroberta@quiqua.it)



Quinto Quarto Edizioni



@quintoquarto

**enjoy  
reading.**